



Changes for the Better

Mitsubishi FA Integrated Solution e-F@ctory

for a greener tomorrow



A solution for advanced factories of the future

e-F@ctory

e-F@ctory Concept

FA-IT Information Products

iQ Platform

Energy Save



Reduce Total Cost of Ownership(TCO) with
e-f@ctory while streamlining production operations.

e-Factory

Making maximum use of shopfloor data is a vital issue, given the increasing complexity of the manufacturing industry today.

Mitsubishi Electric, as a leading FA systems manufacturer, proposes e-F@ctory which has been developed with the aim of reducing production costs across the board, from development and manufacturing to maintenance. Utilizing highly advanced information technologies to optimize factories and support production systems of the future.

Mitsubishi Electric's e-F@ctory concept will offer a solution for your “challenges” and “concerns” by making your plant truly “visible.”



Mitsubishi Electric boasts an extensive lineup of FA products, which has been continually improved upon over the years. Such as Programmable Logic Controllers (PLCs), which is dominant in Asia, Human-Machine Interfaces (HMIs), Inverters, AC servo systems, Electrical Discharge Machines (EDM), and industrial robots, to name a few.

However, to further achieve increase in productivity, the manufacturing industry has leaned towards new FA Integrated solution concepts that are capable of identifying and solving potential issues directly on the shopfloor.

In response to this trend, Mitsubishi Electric has developed the e-F@ctory concept, which utilizes advanced technologies to directly link the shop floor to an IT system.

In addition to making plant processes “visible,” e-F@ctory achieves the optimization of production efficiently by reducing the total cost of the production process with high performance/optimization of production equipment, shortening of development/commissioning times, and reduction of operation/maintenance cost, etc. It furthermore supports energy conservation in the plant by providing “visible energy management.”

How “visible” is your plant? Overcome obstacles with e-F@ctory.

Overcoming common challenges in manufacturing!

The followings are commonly encountered issues in a "invisible" plant.

"Visualization" is a keyword for a solution to the issues facing the manufacturing industry.

To turn "invisible" into "visible", that is, the visualization of manufacturing information is the first step for the solution.

The visibility enables you to catch the present production status in real time even in the place distant from the shop floor.

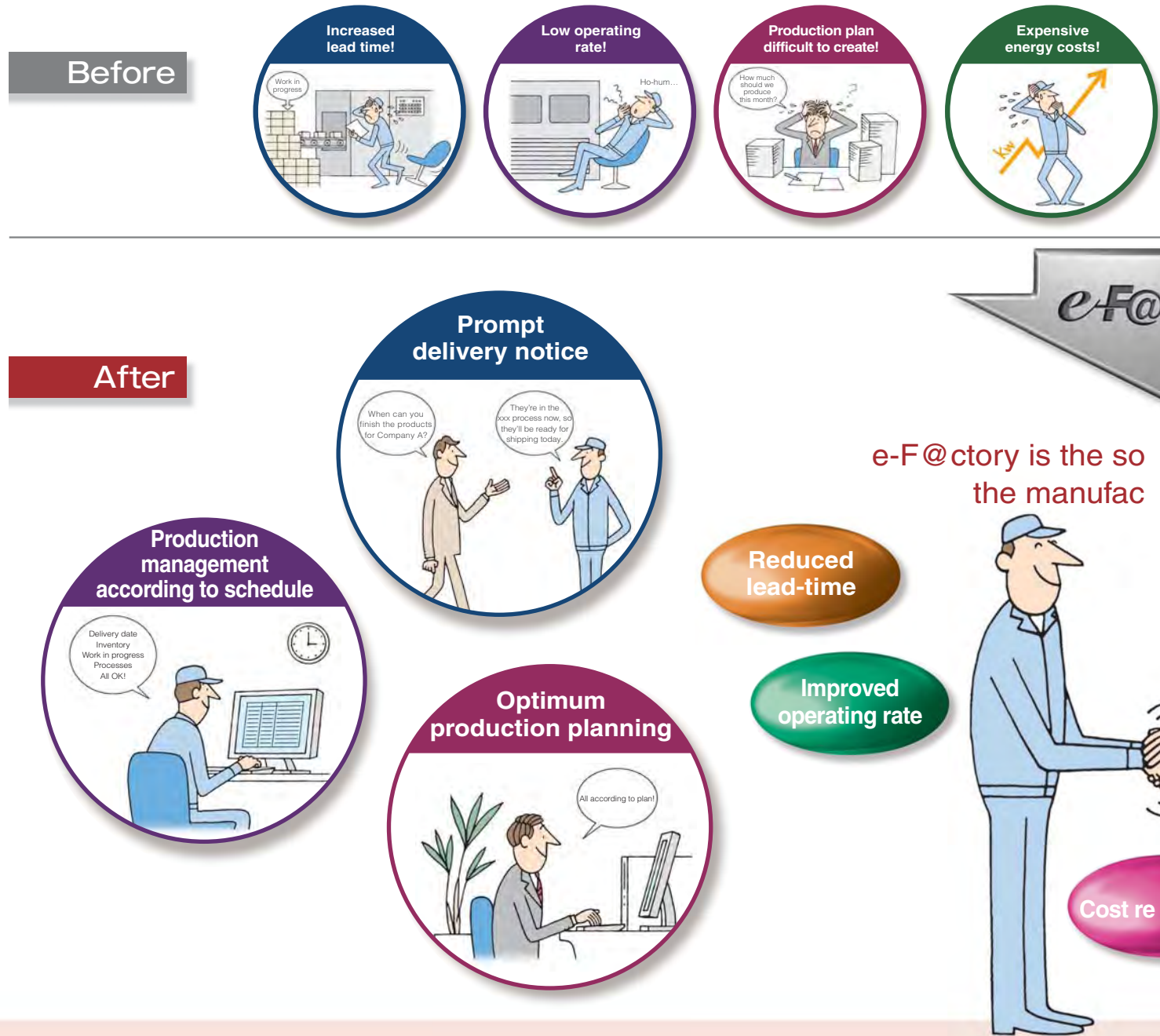

Two aspects of a visible factory of the future.

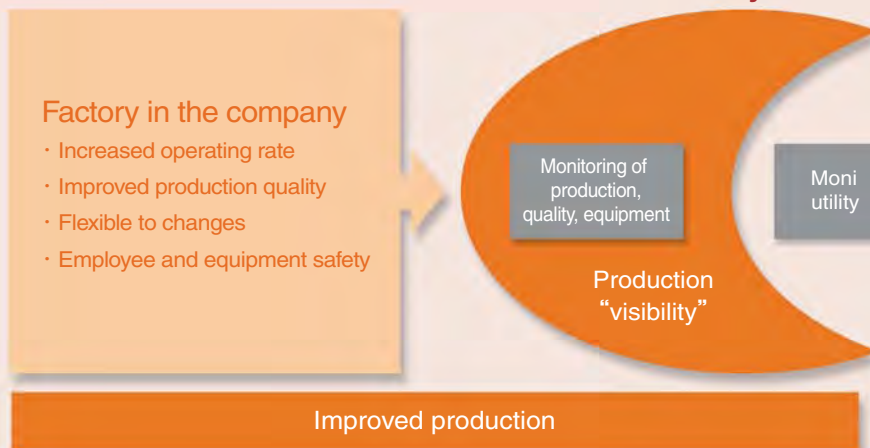

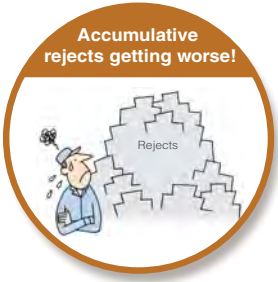

Evolution to issues facing manufacturing industry



“visible” plant

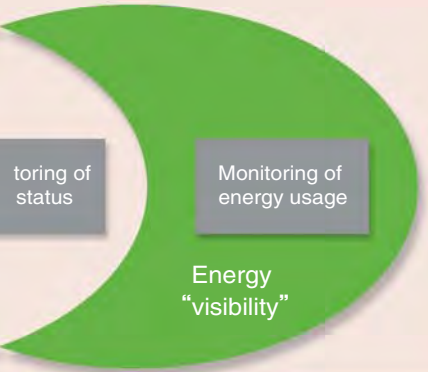

In the future, factories will need to “increase production value” while “living in coexistence with society / environment.” Mitsubishi Electric’s extensive FA product lineup and key partnerships will effectively address these issues. By collecting and analyzing production data, factories will be able to make “visible” the processes needed to increase productivity, reduce waste / emissions, and maintain safety. Mitsubishi Electric provides a total solution for greater improvements.

Co-existence with society / environment

The steps toward creating an e-F@ctory effectively results in fa

An “e-F@ctory-based plant” incorporates a system that is capable of addressing various issues by collecting shop floor data such as production performance, operating performance and quality information from production equipment and devices “directly” and in “real time,” and directly interfacing with enterprise database’s.

In other words, the e-F@ctory platform substantially improves quality, work schedules, and productivity, by having significant vertical data integration from shop floor to enterprise.



FA-IT Information Interface Products

P.7 ▶ P.18

Production system data vertical integrated solution

FA-IT Information Interface Products

MES Interface products are the core of the e-F@ctory information communication technology. They connect production equipment directly to an MES (manufacturing execution system) without the need for PCs or other communication gateways. Information can be shared between the production equipment and the MES easily, and with minimum cost.

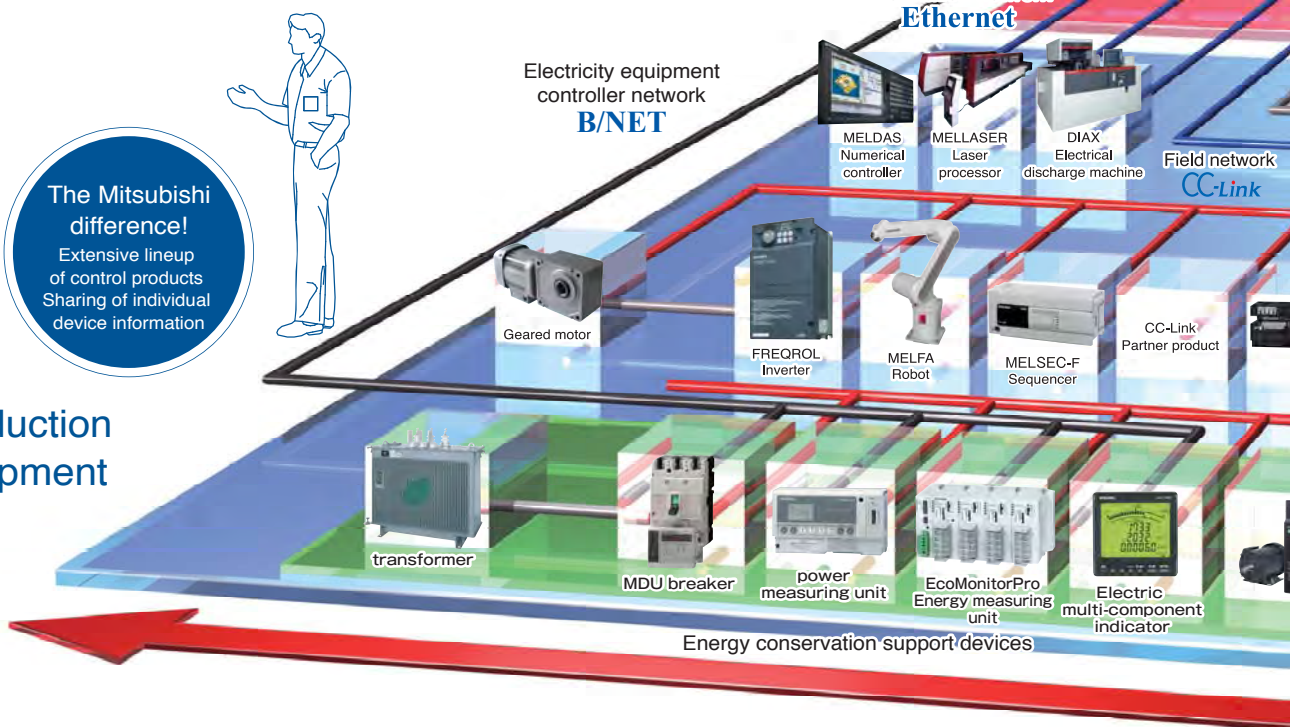

The Mitsubishi difference!
Extensive lineup of control products
Sharing of individual device information

Production equipment

P.19 ▶ P.24

Shop floor optimizing solution

iQ Platform

Increased production data, short production cycles, sudden changes in production volume-if these issues are not addressed, the time it takes from the development of equipment components to commencing the production line will become longer, and it will become difficult to maintain stable quality. iQ Platform addresses such issues from the TCO* perspective.

*TCO : Total Cost of Ownership

actory-wide optimization.

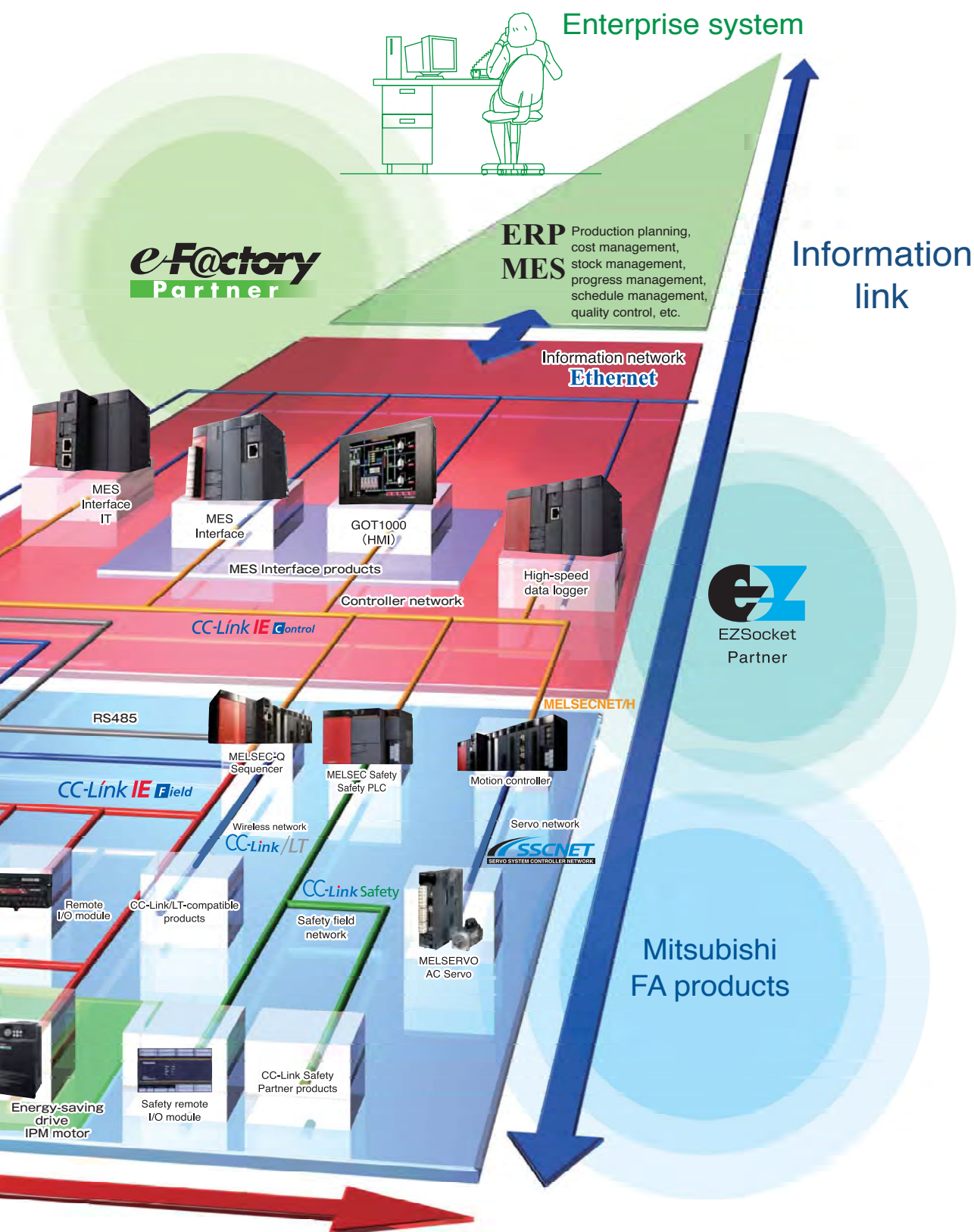

P.25 ▶ P.28

Flexible response to the diverse needs with abundant energy saving support devices

Energy saving solution

Energy saving solution offers an aggressive energy conservation plan, which achieves not only the reduction of costs through energy saving but also close management for every production equipment or line and the reduction of production life cycle cost.

e&ecoFactory

e-Factory Concept



Mitsubishi Electric's advanced FA and IT data communication technologies will draw out the full potential of your plant.

FA-IT Information Interface Products

Flexible to changes, operating rate increase, lead-time reduction, quality improvement, cost reduction - the issues of the manufacturing industry need to be addressed by utilizing all available shop floor data.

FA-IT information interface products are innovative products that embody the e-F@ctory system. They connect production equipment directly to an MES (manufacturing execution system), and further on to a higher IT system.

FA-IT information interface products create a seamless flow of information between production equipment and information systems in response to diverse needs in manufacturing plants.

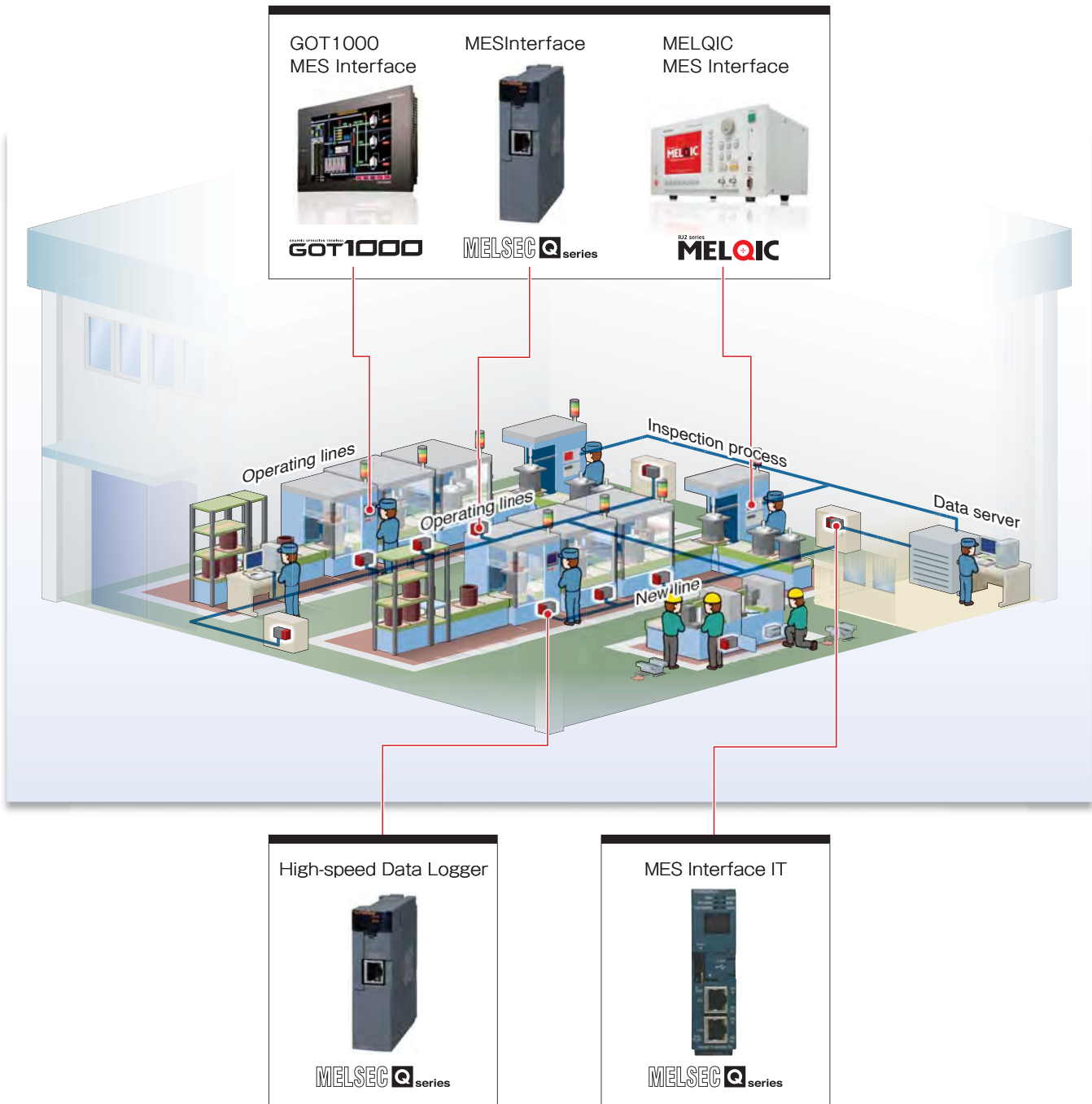

FA-IT Information Products

MES Interface allows information sharing between production equipment and the MES.
 MES Interface IT provides direct connections between the shop floor and information systems in a wide variety of platforms.
 The High-speed Data Logger collects various measurement data directly from production equipment, without installing a dedicated data logging unit.
 From higher information systems to equipment management systems,
 FA-IT information interface products deliver factory-wide optimization.

A broad lineup of MES Interface products provides direct connections between production equipment and an MES with minimum fuss and at minimum cost.

The MES Interface products enable direct connection between the MES (Manufacturing Execution System) database and shop floor equipment, without a communication gateway such as PC required.

In addition to this, information from shop floor devices and 3rd party controllers can be linked by the GOT1000 MES Interface embedded functionality. This product series provides a cost effective solution for visualizing data directly from process devices on the manufacturing floor.



The MES Interface : The key to realizing a visual platform e-F@ctory.

- Provides accurate information in real-time through direct utilization of internal device information
- Simplifies system configuration by directly connecting to databases
- Significantly reduce costs by eliminating the need for PCs and programs
- Improves reliability by eliminating office type products with industrial, i.e. gateway PC changed to MES Interface

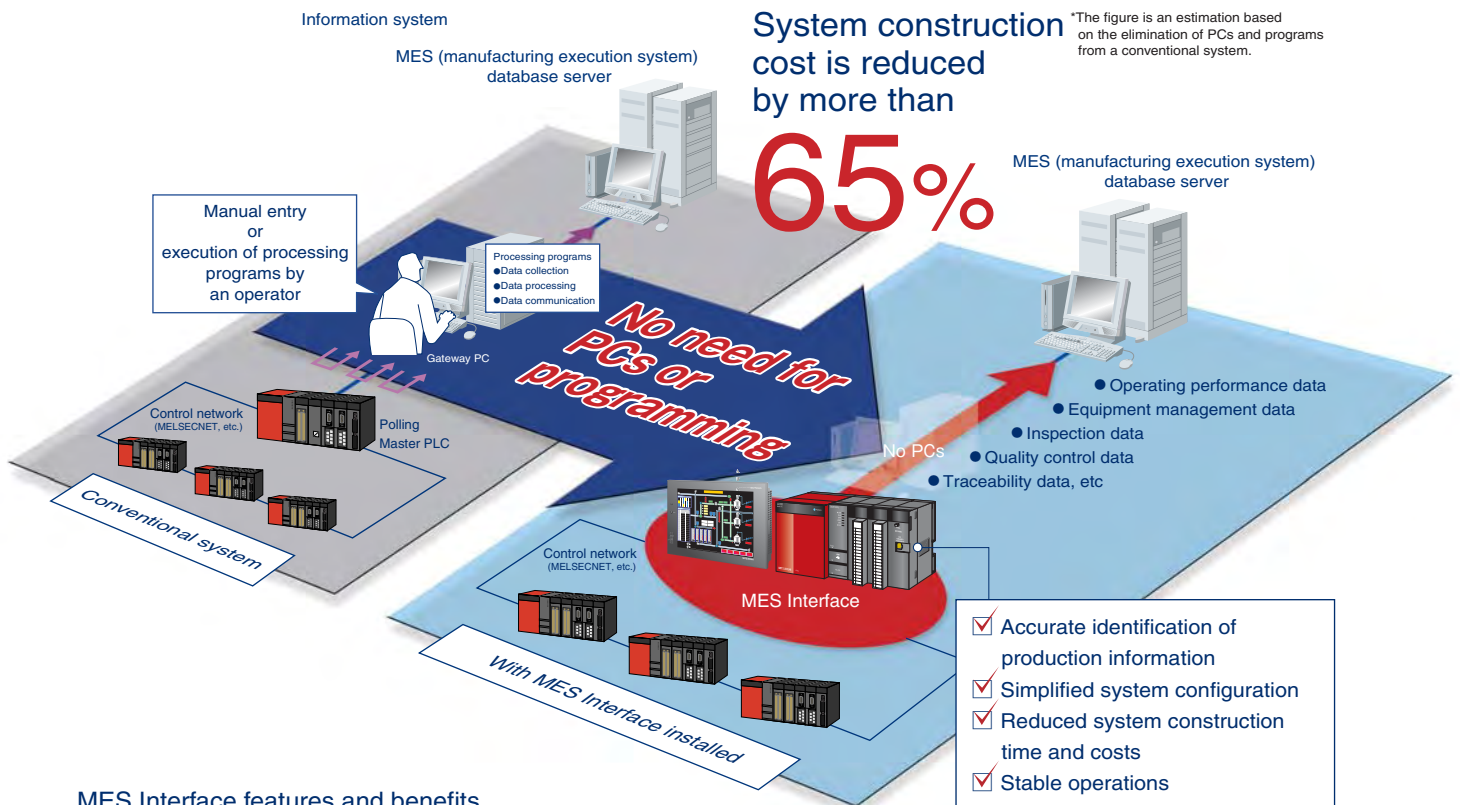

MES Interface features and benefits

- Automatically generate SQL based on simple settings that do not require a program, and facilitate the connection of production equipment to an MES database
- Reduce information system loads by transmitting event driven equipment information
- Receive production instructions from the MES and transmits/receives time-stamped data
- Ensure data reliability by enabling a data buffering function in the event of a communication error

The diverse functions of FA-IT information interface products ensure a seamless flow of information between production equipment and information systems.

Diverse range of cutting-edge functionality ensuring data reliability!

- Temporary buffering of time-stamped data into CF card when communication or server response errors occur. Ensuring zero data loss during transmission maintaining the communication integrity.
- SNTP functionality providing time synchronization between the information system and production equipment, resulting in real-time synchronous data exchange.
- Communication error logging to track even errors, and utilize in reporting tools etc.

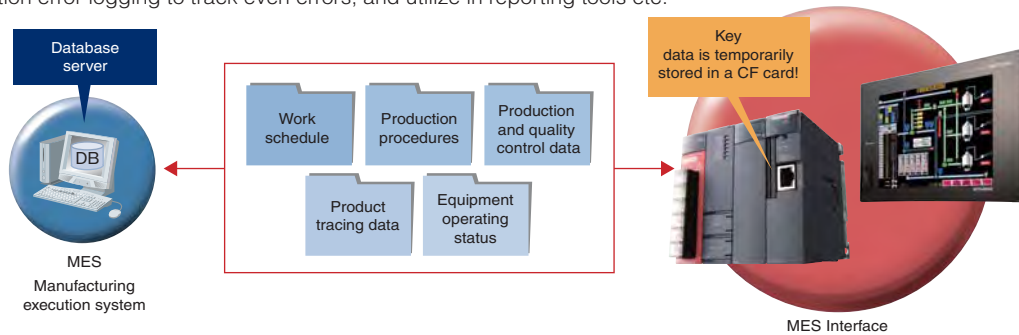

Simple, database connection using intuitive utility setup software!

System development costs can be substantially reduced by using this simple utility software for configuring the connection to database systems. No requirements for running stand alone proprietary executables or having knowledge of difficult database query language needed.

The incorporation of MES Template Package allows assessment and examination of investment effect and performance using a test line, for easy application to the entire plant upon verification of effectiveness.

MES Template Package offers templates of all general functions of the MES system to provide easy production management, traceability, and preparation of Gantt charts.

It will also facilitate the future transition of data to a large-scale database system.

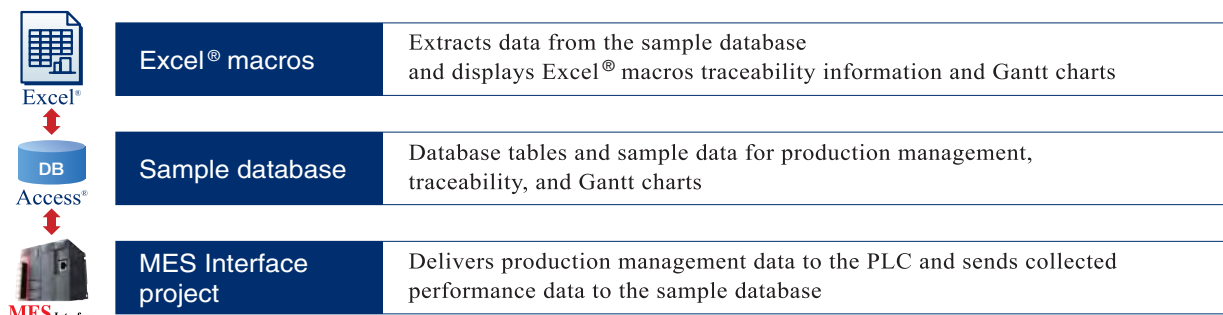

*MES Template Package can be downloaded from the MELFANS website (<http://www.f2.mitsubishielectric.co.jp/melfansweb/english/index.html>).

MELSEC-Q PLC MES Interface

PLCs are connected directly to the MES without the use of gateway PCs or communication programs.

- Comprehensive plant information, including production, equipment, quality, and energy data, are collected and managed via a seamless network.
- Even the most detailed equipment-level information can be collected via an extensive field network.
- Machine tools and equipment that utilize third-party PLCs can be easily configured into the open network.



MELSEC Q series

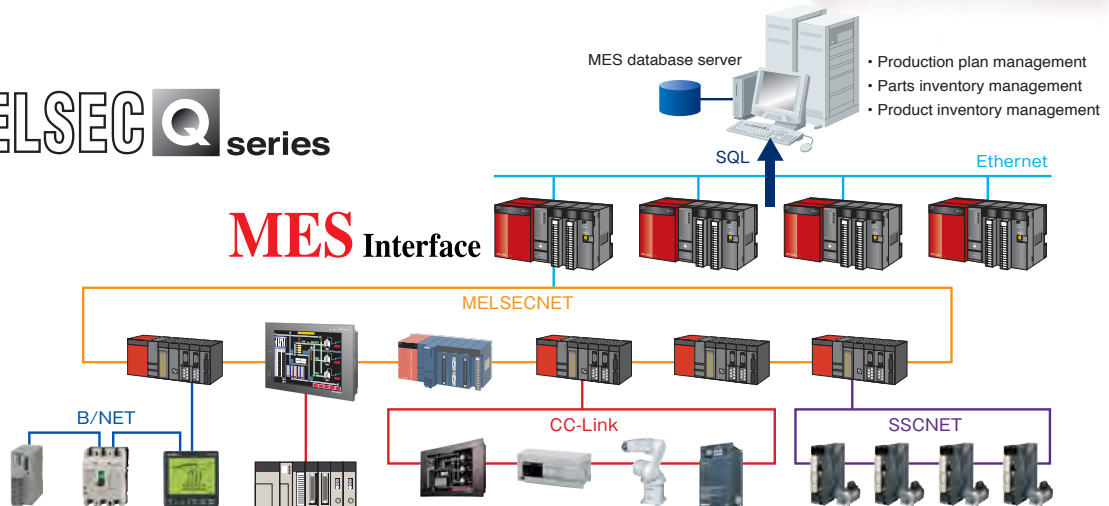

GOT1000 HMI MES Interface

The GOT1000 HMI collects and sends data from connected FA products to the MES.

- Collects data from existing equipment and other equipment that utilize third-party PLCs.
- Supports operators' tasks by providing access to a barcode reader, document viewer, or other such tools.
- Provides detailed information management functions that are only available in an HMI, including historical trending and logging, management of alarm histories such as equipment alarms and production history, and management of operators' operational history.

GRAPHIC OPERATION TERMINAL
GOT1000

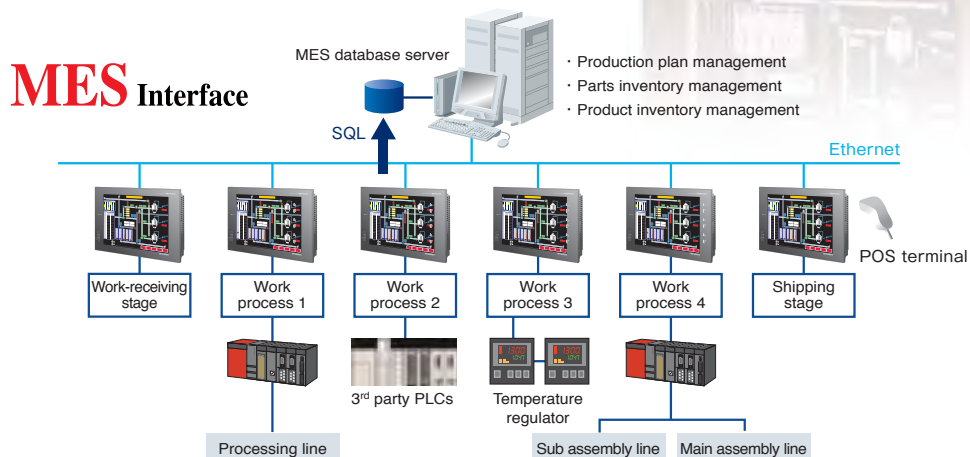

MES Interface IT for MELSEC-Q PLCs

Greater compatibility with diverse platforms and databases ensures direct connections between the shop floor and information systems.

- Eliminates the need for communication gateway PCs and programs, and provides a simple information collection system at low cost
- Supports a variety of communication protocols to provide direct connections with a wide range of information systems and compatibility with large-scale IT platforms
- Simple tools ensure easy setup and easy mapping of data from PLCs and information systems

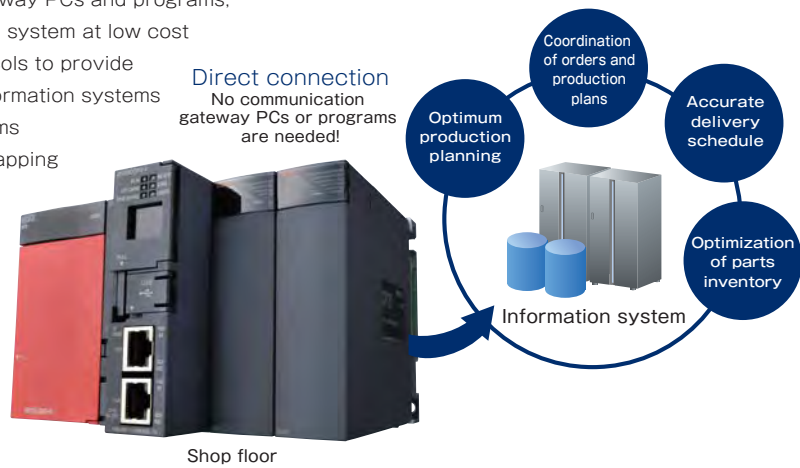

■ Main differences between MES Interface and MES Interface IT

Item	MES Interface	MES Interface IT
Compatible databases	MS SQL Server, MS Access, Oracle, Wonderware, Historian	DB2, MS SQL, Oracle
Message communication and other communication programs	—	Message communication programs: WMQ, JMS, Microsoft MQ Other communication programs: TCP, e-Mail
Information system platforms	Windows	UNIX systems, LINUX, Windows (compatible with all types of information system platforms)

High-speed Data Logger Module for MELSEC-Q PLCs

Designed specifically for MELSEC-Q Series PLCs, the new data logging module can be easily installed in the PLC CPU and set up to provide efficient data logging solutions.



Various measurement data are directly collected by the data logger to provide high-speed, easy, and low-cost data logging solutions with greater precision than conventional modules. Because there is no need to install PCs or dedicated devices on the shop floor, using the data logger contributes to minimizing system costs and improving system reliability.

- Records data at high speed and with high precision, in synchronization with sequence scanning, which is the smallest time unit of control.
- An Assistant Wizard helps set up the appropriate logging method for the intended use, and the Viewer Utility generates trend graphs to facilitate data monitoring and analyses.
- Since no PC or protocol converter is needed to collect data, initial costs can be kept extremely low.

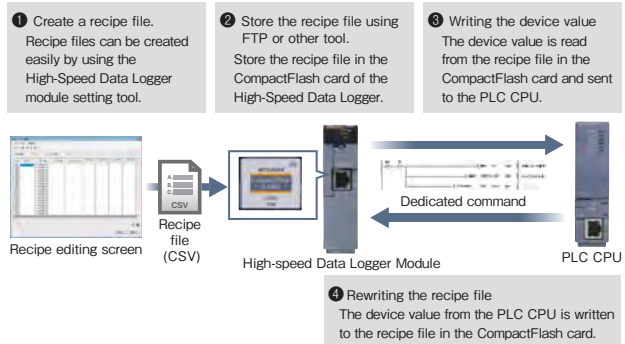
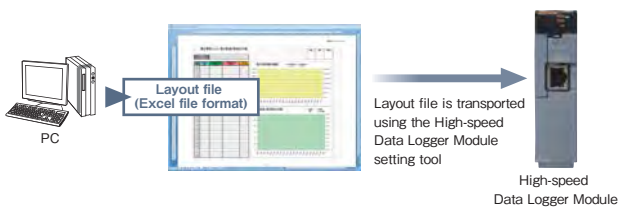

Graphical displays of daily reports, business logs, reports, and other such materials are automatically generated, as needed.



[Changing the production line setup in accordance with the recipe file]

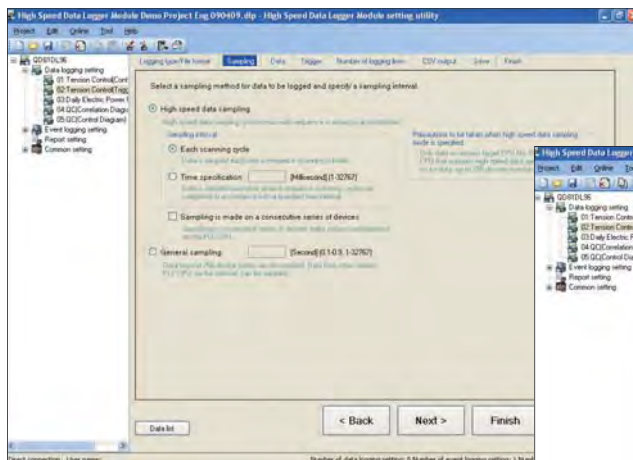
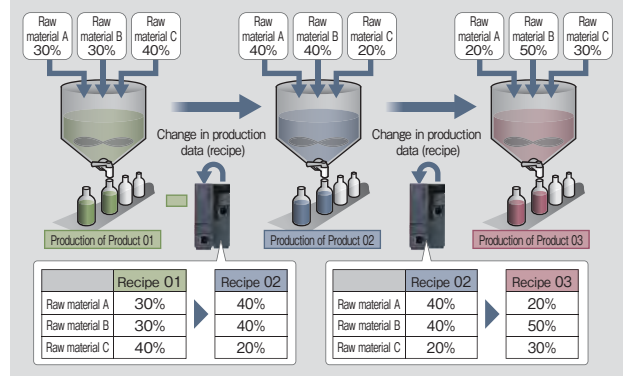

Sample data collection screen

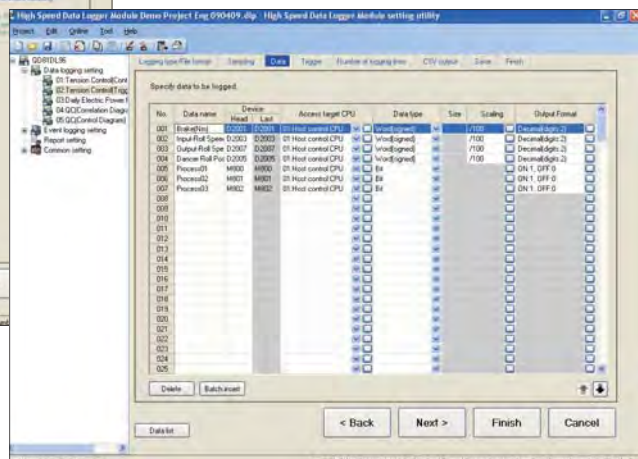

Sample data display screen

New High-speed Data Logger provides solutions to all types of data logging needs without a PC.

Data is recorded in synchronization with sequence scanning!

The High-speed Data Sampling Function synchronizes the data logging task with sequence scanning, which is the smallest time unit of control, to ensure high-speed, high-precision data logging.

The sampled data can be used not only to analyze machine performance, but also to identify the cause of errors when they occur, because the data logger records even the smallest change in control values.

Data sampling by the High-speed Data Logger (High-speed sampling interval: 1ms at the fastest)



The control value has exceeded its limit. Let's adjust the equipment!

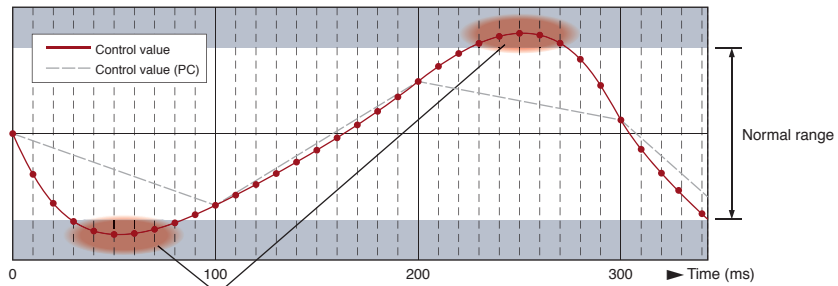

Causes of errors that might be missed by conventional data logging systems

The cause of errors cannot be detected in the logging data

Typical data sampling using a PC or other externally-connected device (100ms intervals)



The logging data doesn't seem to indicate any problems...

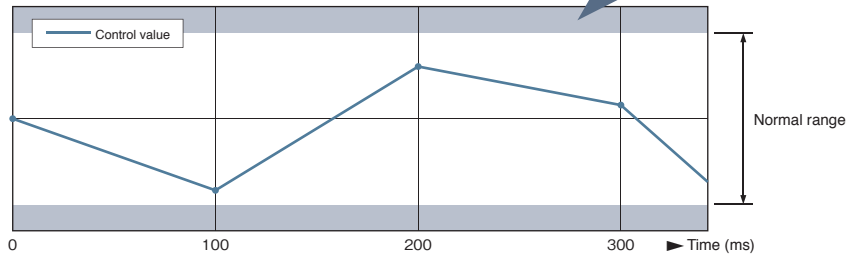

Prompt analysis of a problem when an error occurs

The Trigger Logging Function records data before, during and after a specified trigger, so that when an error occurs, the data can provide important information for prompt identification of cause and quick recovery.

Furthermore, when potential causes of errors are specified as triggers, the data logger only saves data close to the trigger occurrence, so CompactFlash card memory can be used efficiently.

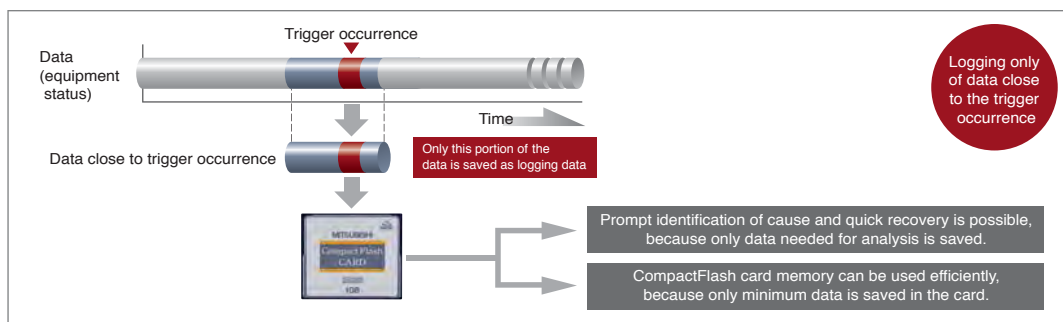

■ Data saved in CSV file format

Generation of trend graph using Viewer Utility

■ High-speed Data Logger Viewer Utility

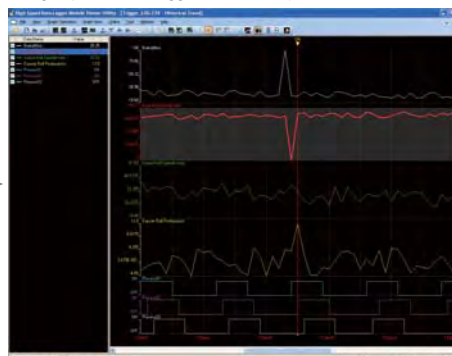

MES Interface Functions

Functions	Description
DB Interface	Executes access to the target database in units of jobs.
Tag information collection	Assigns a tag element name to equipment information (controller memory address) and collects information in units of tags
Trigger monitoring	Monitors time, tag and other values, and activates a job according to trigger conditions.
SQL message transmission	Automatically generates SQL messages and communicates with the database.
Arithmetic processing	Calculates the value of tag elements.
Database buffering	Buffers SQL messages that could not be transmitted due to network disconnection or failure of the database server PC into internal CF card. After recovery, the buffered SQL messages are automatically resent to the database (manual operation is also possible).
Remote operation	Executes remote operation requests in the form of XML messages from user applications.
Time synchronization	Synchronizes the time data used in sending and receiving data with a network SNTP server or PLC CPU (internal clock, in the case of GOT and MELQIC).
Message communication	Sends and receives message data with higher information systems.
Security	Specifies the information that can be accessed and functions that can be used by each user. Secures a proper level of security when configuring systems between different departments or different companies.

MES Interface Specifications

Functions	MES Interface (QJ71MES96)	MES Interface IT (Q12DCCPU-V)	
Database connection	Supported databases		
	Oracle 8i,9i	○	—
	Oracle 10g	○	○
	Oracle 11g	○	○
	SQL server 2000 and higher	○	○
	Access 2000,2003	○	—
	Local database (within module)	—	○
	IBM DB2 (8, 9)	—	○
	Wonderware Historian 9.0	○	—
	Trigger conditions		
	Fixed cycle	○	○
	Fixed time	○	○
	Value monitoring	○	○
	At unit startup	○	○
	Listener	—	○
	Manual	○	○
	Sub-trigger	—	○
	Higher communication event	—	○
	Multiple CPU/machine event	—	○
	Other events	—	○
Job			
Allowable number of actions	10 per job	Unlimited (depends on CF memory)	
Allowable number of arithmetic actions	20 per action		
Types of SQL actions	4 types Select · Update · Insert · Delete	9 types Select · Update · Insert · Delete(delete) · Batch Insert(multiple insert) · Select with Delete · Select with Update · CountRows(count) · Stored Procedure	
Arithmetic action operators	6 types (four arithmetic operations, residue calculation, character string connection)	20 types (four arithmetic operations, trigonometric functions, maximum/minimum average, etc.)	
Device tag			
Number of tags	64 per project	Unlimited (depends on CF memory)	
Number of elements	256 per job, 4096 per project		
Database buffering			
	○	○	
Remote operation	○	—	
Time synchronization	○	○	
Message communication	—	WebSphere MQ · JMS · TCP · Microsoft MQ	
Security	○	○	

MELSEC-Q PLC MES Interface module

Product name	Model	Description
MES interface module	QJ71MES96	MES Interface function executing module
CompactFlash card	—	Required. 128 Mbytes or more

MELSEC-Q PLC MES Interface IT (hardware)

Product name	Model	Description
C language controller	Q12DCCPU-V	MES Interface function executing module
CompactFlash card	—	Required. 128 Mbytes or more

GOT1000 MES Interface function

Product name	Model	Description
GOT1000	GT16□□-□□□□	GT16 series GOT module
Optional function board	GT16-MESB	MES Interface function executing board
CompactFlash card	—	Required. 128Mbytes or more

MELQIC MES Interface function

Product name	Model	Description
Intelligent inspection unit	IU2-□□□□□□	IU2 series MELQIC module
MES Interface board	IU2-1EMES	MES Interface function executing board
CompactFlash card	—	Required. 128Mbytes or more

MELSEC-Q PLC MES Interface module dedicated information interface tool

Product name	Model	Description
Information Interface Tool (MX MES Interface)	SW1DNC-MESIF-J	Sets MES interface actions, etc.

MELSEC-Q PLC MES Interface IT setting tool (software)

Product name	Model	Description
MES Interface IT	VN-SWMIT1-E	Setting tool (WorkBench), Runtime Software

* A transport license is required for database connection. See the MES Interface IT catalog for details.

GOT1000 MES Interface setting tool (either of the following mandatory)

Product name	Model	Description
GT Works3 Version 1	SW1DNC-GTWK3-J	Tool for setting MES Interface functions and for editing the database connection service set-up screen

MELQIC MES Interface function dedicated information interface tool

Product name	Model	Description
Information Interface Tool (IU MES Interface)	SW1DNC-IUMIF	Sets MES Interface actions, etc.

High-speed Data Logger Functions

Functions	Description
High-speed data sampling	Samples data at high speed, in synchronization with sequence scanning (1ms at the fastest).
Logging	Samples and records data and event information.
Data logging	Records data continuously or when a trigger occurs.
Event logging	Chronologically records the occurrence of a specified event.
FTP server	Allows PC-based FTP client software to retrieve and delete files stored in the High-speed Data Logger.
FTP client	Allows files stored in the High-speed Data Logger to be transferred to a PC-based FTP server.
E-mail transmission	Sends event notices and stored files to a PC or other external unit by e-mail.
Excel file storage	Stores the collected data in Excel format (report function).
CSV file storage	Stores the collected data in CSV format.
Time synchronization	Synchronizes the time data used in sampling data with a network SNTP server or PLC CPU (internal clock, in the case of GOT and MELQIC).

High-speed Data Logger Specifications

Functions		Data logging	Event logging	
High-speed data sampling	Number of settings	Max. 64 (data logging, event logging and report settings combined)		
Logging	Type of logging modes	Continuous logging, trigger logging	Event logging	
	File format	CSV file (extension: CSV) Binary file (extension: BIN) Excel file (extension: XLS) *Report function	CSV file (extension: CSV) Binary file (extension: BIN)	
	Duration	Data conditions: Bit on/off, comparison of data with constant value, comparison of data with data Date range: Specify month and day of starting/stopping logging Time range: Specify hour, minute, and second of starting/stopping logging Day-of-week/week-of-month conditions: Specify day of week or week of month AND/OR operations of the above: Up to 7 conditions		
	Activation conditions	Data conditions: Bit on/off, comparison of data with constant value comparison of data with data Change in data Fixed cycle: 1 to 86400 sec Specified time: Specify month, day, hour, minute, second At start-up of module AND/OR operations of the above: Up to 8 conditions Number of conditions to be met: 3 Order of conditions to be met (order and time): Up to 4	Data conditions: Bit on/off, comparison of data with constant value, comparison of data with data Change in data AND/OR operations of the above: Up to 4 conditions Number of conditions to be met: 3 Order of conditions to be met (order and time): Up to 4	
	Number of logging lines	Trigger logging: 0 - 32767 lines before, 1 - 32767 after, trigger occurrence		
	File switching timing	Specified number of lines (number of records): 100 to 65535 Specified file size: 10 to 16384KB Fixed cycle: 1 to 86400 sec Specified time: Specify month, day, hour, minute, second At start-up of module At each trigger logging	Specified number of lines (number of records): 100 to 65535 Specified file size: 10 to 16384KB Fixed cycle: 1 to 86400 sec Specified time: Specify month, day, hour, minute, second At start-up of module	
	Name of stored files	Serial number (hexadecimal 8-digit numbers) The following options may also be specified in addition to the above: Fixed character string, time (year, month, day, hour, minute, second), data value (up to 2)		
	Allowable number of stored files	1 to 65535		
	Automatic deletion of stored files	Specify by number of stored files or by the amount of free space in the CompactFlash card		
	FTP server	Action-confirmed FTP client software	Microsoft Internet Explorer 6.0/7.0	
	Number of sessions	10		
FTP client	Action-confirmed FTP server	Microsoft Internet Information Service		
E-mail transmission	Type	Transmission of event notices, stored files		
	File attachment	Event notification e-mail: None E-mail of stored file: Stored file (CSV, binary, Excel), max. 512KB		
	Attachment type	MIME1.0		
	Communication with mail server	Port number	25,587, others (1 to 65535)	
		Authentication	No authentication, SMTP-AUTH (PLAIN, LOGIN, DIGEST-MD5), POP before SMTP	
	Destination address	Up to 16 groups		
	Action-confirmed mail client software	Microsoft Outlook Express 6.0, Microsoft Windows Mail 6.0		

MELSEC-Q PLC High Speed Data Logger Module

Product name	Model	Description
High-speed Data Logger	QD81DL96	High-speed data logger module *Requires a CompactFlash card
CompactFlash card	QD81MEM-512MBC	512MB
	QD81MEM-1GBC	1GB
	QD81MEM-2GBC	2GB
	QD81MEM-4GBC	4GB
	QD81MEM-8GBC	8GB

MELSEC-Q PLC High Speed Data Logger Module Viewer Utility

Product name	Model	Description
High Speed Data Logger Module Viewer Utility	—	Tool for displaying and analyzing sampled data * May be downloaded free from the MELFANS website

* See High Speed Data Logger Module catalog for details.

Applying e-F@actory to various different types of applications, su

Application example Production management system

Manages operational performance data(production volume, cycle time, etc.).

This system provides a means of efficiently managing production process status(production quantity, cycle time) and checking the error history of different aspects of the line. Device data is easily collected from various controllers via the controller network and communicated directly to a database server via MES Interface.

[Installation effects]

- Efficiently manage production performances.
- Effectively realize quick recovery and intelligent preventative maintenance measures by proper management of real time errors and historical data.

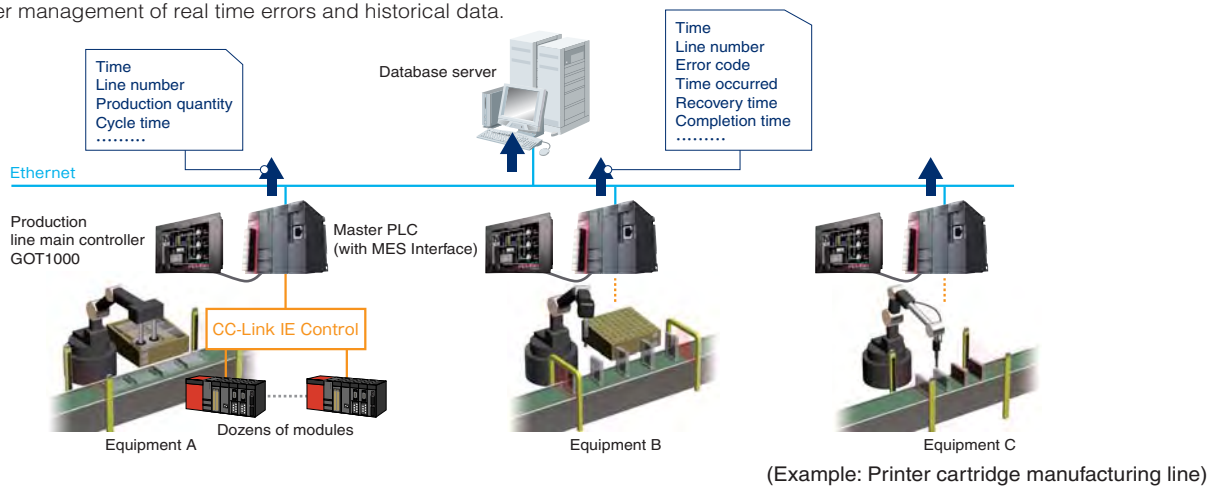

Application example Alarm information management system

Collects error information and in case of an error, information can be input/sent from HMI.

By having an alarm management system incorporated into the production line, various detailed information such as process, error description, cause, etc., can be efficiently collected and managed. This system reads a recipe information such as operator, error description, etc. when it starts up and detailed information in the event of an error can be input and sent from HMI.

[Installation effects]

- Automated alarm management provides accurate and fast analysis of errors.
- Equipment maintenance procedures are improved substantially by managing detailed information within the server.

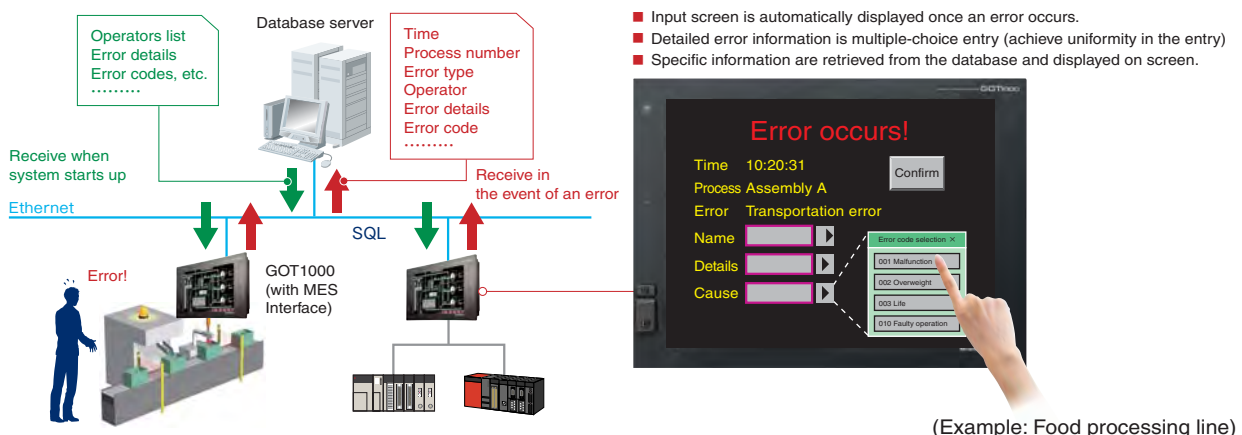

ited for the users best needs.

Application example Traceability system

Ensuring accumulative collection of production process data such as process number, operation history, and quality directly from the shop floor.

Critical data such as equipment number, operation history, and quality data are collected from each individual process or machining point and fed directly to the database server. The serial number of each machining process (engine), processing history, and inspection history are sent to the database after completion.

[Installation effects]

- Traceability data can be used to respond promptly to production down situations and quality faults.
- Trends in operation status and quality information are closely monitored, highlighting production quality variances effectively in real time.

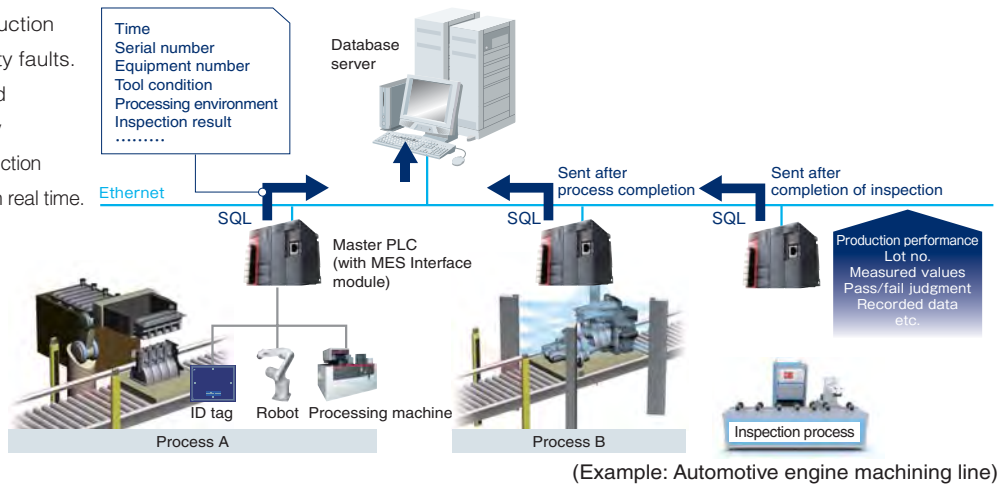

Application example Ingredient ratio management system

Allows management of ingredient ratio data by PC, to ensure smooth changes in ingredient ratios per product.

The ingredient ratio data for each product is managed as a recipe file by a personal computer.

Using the FTP server function, the recipe files are stored on the CompactFlash card of the High-speed Data Logger Module.

When changing products on the production line, a dedicated command retrieves the relevant recipe file needed for production.

[Installation effects]

- Shortens the time needed to change products.
- Prevents human errors when setting parameters for product changes.

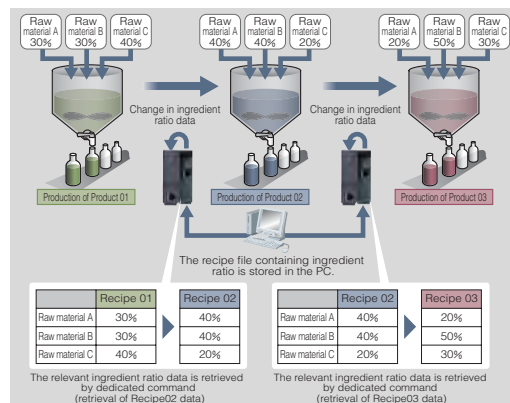
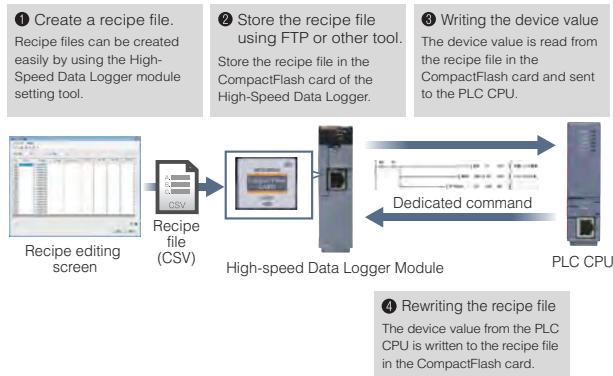



Reduce Total Cost
of Ownership (TCO) with

iQ Platform

Mitsubishi Electric not only offers vertical integration with its MES Interfaces, but also offers horizontal hardware integration of all its automation products on the shop floor.

This is achieved and designed around the iQ Platform, which is a consolidated automation platform bringing all aspects of automation onto one main programmable automation controller.

The design highlights the integration of controllers, CNCs, Robots, HMIs, engineering environment, and networking, hence resulting in reduced TCO.

iQ Platform opens up the future of automation, by integrating, optimizing, and innovating the shop floor, resulting in reduced TCO.

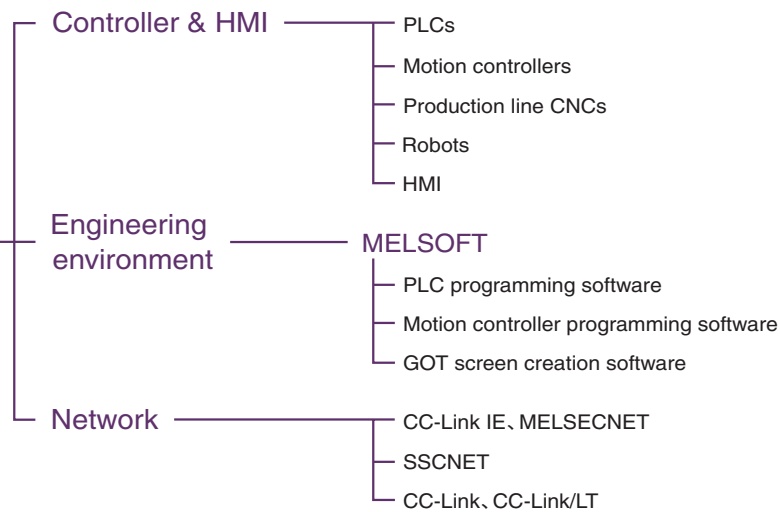

*TCO: Total Cost of Ownership

iQ Platform controller and HMI

- High-speed, large-volume communication between MELSEC-Q series multiple CPUs (approx. 8 times faster communication speed, 3.5 times larger shared memory)
- Dramatic increase in logic processing capacity and memory (3.5 times greater basic command processing performance, 6 times larger file register)
- High-speed motion processing (2 times greater basic performance), shorter device and equipment cycle time, compact MELSEC-Q size, diverse product lineup
- Fully compatible with production line CNCs and robots

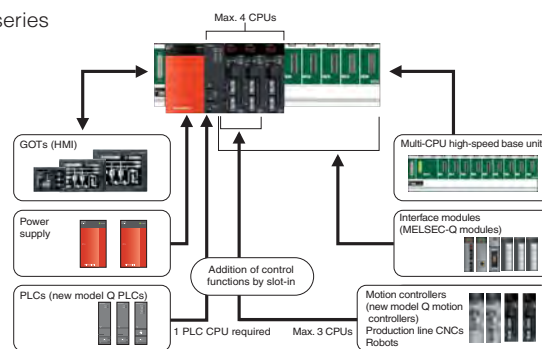

iQ Platform engineering environments

- Supporting all stages of the project, from start to finish
- PLC, motion controller, and GOT engineering environments
- Intuitive development environment providing an efficient method for systems design and implantation, resulting in significant reduction of overall engineering costs

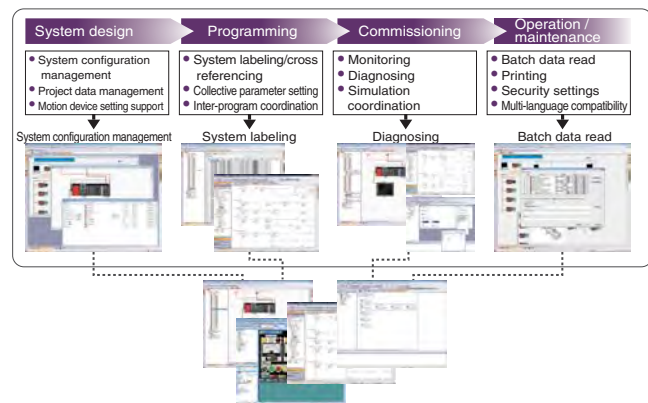

iQ Platform networking

- High-speed and large data volume communication based on cutting-edge gigabit Ethernet technology
- Significant cost reduction with the use of standard Ethernet-based cables and connectors
- High end performance through cyclic network shared memory
- 256Kbyte network shared memory (cyclic data) on a single network

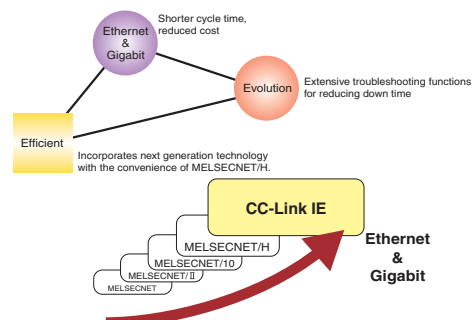

iQ Platform

iQ Platform controller and HMI achieve multiple CPU high-speed

The effective coordination of high-speed communication between multiple CPUs provides even higher speed control.

The iQ platform consists of a ultra high speed multi CPU main base unit, realizing high speed communication across the backplane between high-speed and high-capacity PLC CPUs, and high-speed and high-precision motion controllers. Compatibility of sequence control and drive control has improved drastically, and complicated machine control can be performed high-speed and easily.

By adding the GOT1000 range of high function HMIs, the iQ platform provides a true integrated automation platform from all aspects of the application. Production line CNCs and robots are also supported.

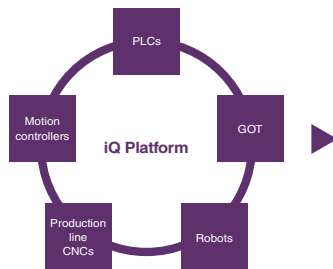

Realizing the factory of the future with high end controllers.

Development cost reduction <ul style="list-style-type: none"> ■ Reduction in equipment design time ■ Reduction in commissioning time 	Production cost reduction <ul style="list-style-type: none"> ■ Shorter cycle and operation times ■ Integration with higher information systems 	Maintenance cost reduction <ul style="list-style-type: none"> ■ Utilization of MELSEC-Q series ■ Reduced down time
---	---	---

Cutting edge technology with flexibility in application needs.

iQ Platform PLC

Achieve ultra high speeds of nano order and large data handling functionality

- Reduced operation times with higher processing performance

Basic command processing time (LD command) of 9.5ns is realized.

- High-speed, high-precision real data processing

Substantial fast processing speeds for Real number (floating point), realize speeds for add operation instruction of 0.05 μs.

		Q04/06UD(E)HCPU	Q02/06HCPU
operation (E*)	Single precision (μs)	0.057	0.78
	Multiple precision (μs)	4.3*1	87*2
SIN operation (45 deg)	Single precision (μs)	4.1*1	50
	Multiple precision (μs)	8.5*1	837*2

*1 Minimum value *2 Processing time of internal multiple-precision computing

- Easy handling of large-volume data

Standard RAM has been increased, used as a file register for storing data.

Standard RAM capacity (file register volume)		
Q03UDCPU	Q04UDHCPU	Q06UDHCPU
192kB (96k words)	256kB (128k words)	768kB (384k words)

iQ Platform motion controller

New algorithm provides higher speed, higher precision.

- High-speed bus between multiple CPUs

MAX. of 14k words can be converted per 0.88ms. Communication cycle synchronizes with motion control.

- High speed high precision motion control

Motion basic performance is improved to approx. 2 times, and motion SFC processing time is reduced to approx. 1/4.

Basic motion performance
(number of control axes during a 0.44ms computing cycle) *In the case of SV13

Motion SFC processing time *Processing time of D800L = D802L + D804L

- Program data read/write time substantially reduced

Program data read/write time is reduced to about approx. 1/3, with fault diagnostics functionality also improved.

Motion communication performance
(servo program read time)

communication.

iQ Platform production line CNCs

Production line CNCs well suited for the automotive industry.



■ **Multiple CPU high speed communication**
 Cycle/operation time is reduced by multiple CPU high speed data exchange. Existing modules can also be utilized.

High-speed data communication between PLC CPUs and CNC CPUs

■ **High-performance CNC CPU**
 CNC CPU performance is also increased by double. High speed communications from the NC control processing to sequence control and host communications.

2 times greater block processing capacity!

C70 (parts processing line CNC)	16.8kBlock/min
C64 (parts processing line CNC)	8.4kBlock/min

■ **Cycle time is greatly reduced**
 Scan time and M-code processing time substantially reduced resulting in shorter operation times on the shop floor.

Scan time: 20 - 30 times faster

M-code processing time: 3 - 5 times faster

The graphs show performance comparisons when giving C70 a value of 1.

iQ Platform robot controller

Robots and PLCs are directly connected by iQ Automation.



■ **Control performance is greatly enhanced**
 I/O processing time is greatly reduced by high speed communication between PLC and robot.

High-speed PLC RobotCPU

High-speed communication

New high-speed communication equipment developed specifically for iQ Platform (14k word/0.88ms)

■ **System cost is also reduced**
 Peripheral devices can be reduced by the expansion of I/O points with 1024 words between PLC and robot.

Conventional products

Q-bus slot-in

■ **Reduced wiring connections**
 Less wiring is realized by the direct connection with PLC. Construction time and costs are substantially reduced.

Wiring equal to number of I/O points

No wiring is needed because of Q-bus slot-in

Conventional product

iQ Platform HMI

Realize high end HMI functionality, with unique project back-up/restore functionality.



■ **Utilize "Backup/Restore Function" with ease**
 Backup project data such as sequence program or parameters of PLC CPU to GOT's CF card.

By backing up data...

Exchange CPUs

Logic programs, etc.

CF card

Restore

Direct CPU connection

■ **FA transparent function provides easy modification at shop floor**
 Programming, startup and adjustment of FA equipment can be performed from the GOT by connecting GOT with a PC.

USB / RS-232

PC for programming and software setup

MELSECNET, etc.

PLC

Servo amp

Direct CPU connection/bus connection

iQ Platform

iQ Platform engineering environment, which integrates the functions required in each phase of development.

Data, communications, operability... An engineering environment beyond the boundaries of FA Components is expanding.

iQ Platform engineering environment is a development environment that can share design information among all phases from system design, programming, and commissioning to operation/maintenance.

In addition, it integrates various programming software tools such as PLC, motion controller, and GOT, which were separated conventionally.

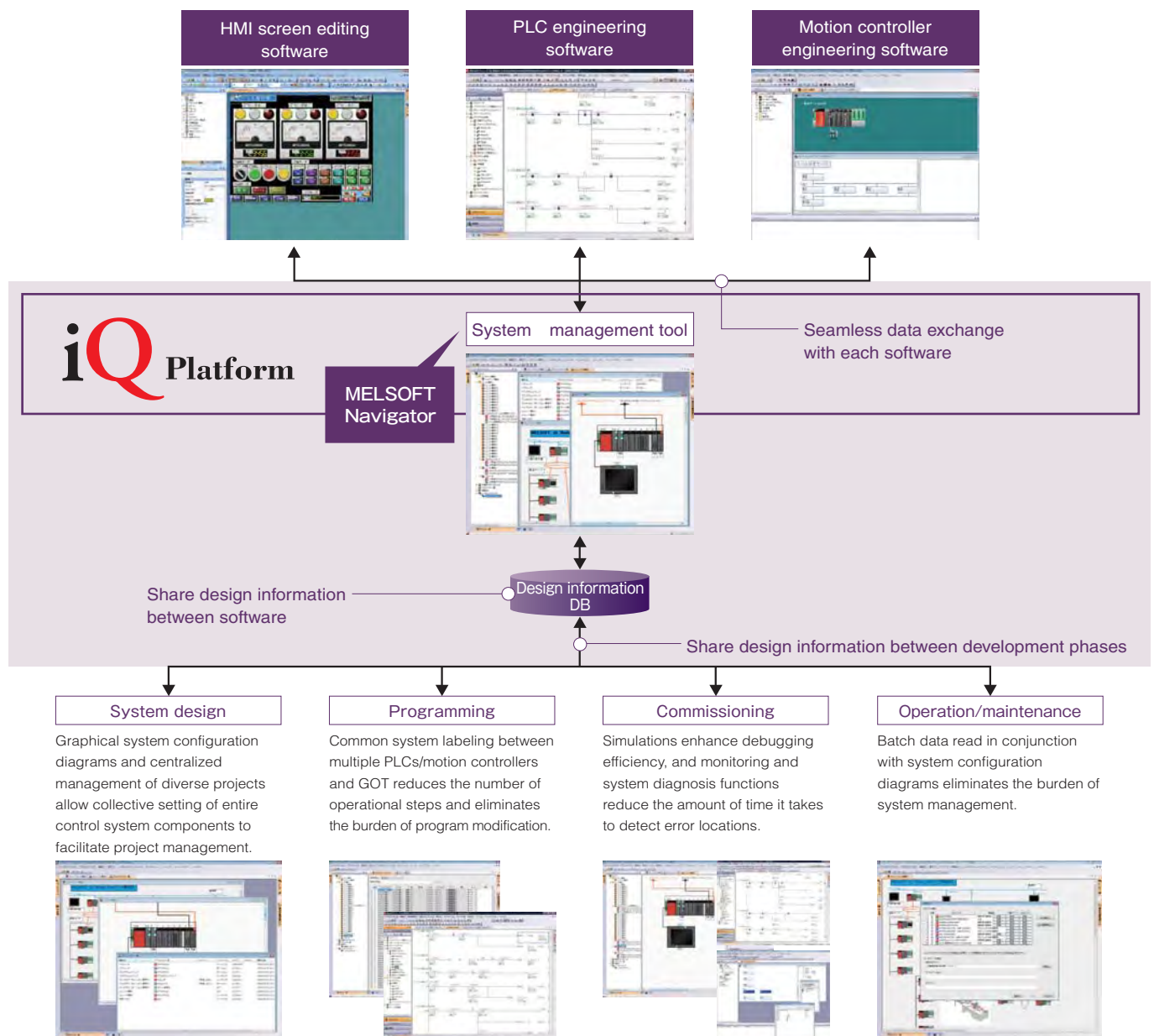
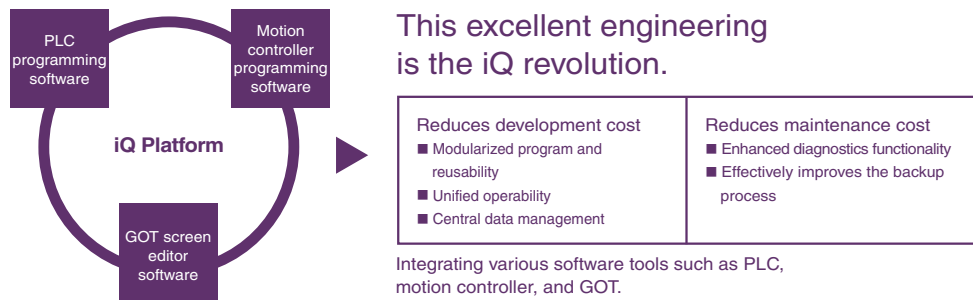

Ethernet
Open Network

CC-Link IE

Offers seamless connection, from higher information systems to lower field systems, for optimum networking needs and applications.

CC-Link IE Field Gigabit Ethernet

All-around, Flexible Network Topology

CC-Link IE Field is an all-around field network that integrally provides distributed control, I/O control, safety control, and motion control*1. Network connections can be made in star, line, or ring topologies, in correspondence with diverse lines, devices, and equipment layouts. Furthermore, a safe communication function allows exchanges of safety information among multiple safety PLCs.

Logo for the CC-Link IE Field Network CC-Link IE Field Safety safe communication function

Communication speed 1 Gbps	Max. link capacity 16K words	Max. link capacity 32K bits
Star topography	Line topography	Ring topography
Easy parameter settings	At-a-glance network diagnosis	Seamless connections
Metal cables	Ethernet network	Safe communication function

CC-Link IE Control Gigabit Ethernet

High Speed, High Capacity & High Reliability

CC-Link IE Control is a high-reliability controller network that integrates various controls with diverse functions, including optical double loops and external power supplies. A maximum link capacity of 128K words ensures more than sufficient control of ever-increasing recipe files and traceability data.

Communication speed 1 Gbps	Max. link capacity 128K words	Max. link capacity 32K bits
Ring topography	Optical double loops	External power supply functions
Easy parameter settings	At-a-glance network diagnosis	Seamless connections
Optical cables	Ethernet network	

CC-Link CC-Link Safety CC-Link/LT

Open field networks that are compatible with the more than 1,000 types of partner products are available, from wireless devices to safety equipment.



A high-speed, high-reliability synchronous motion network.

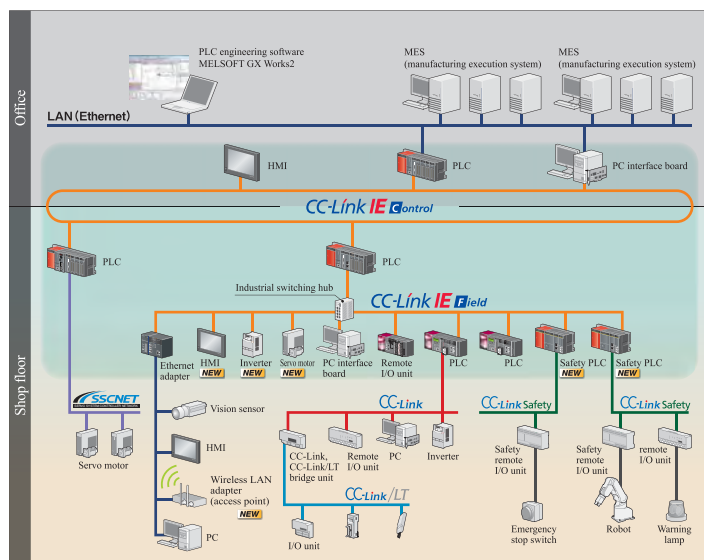
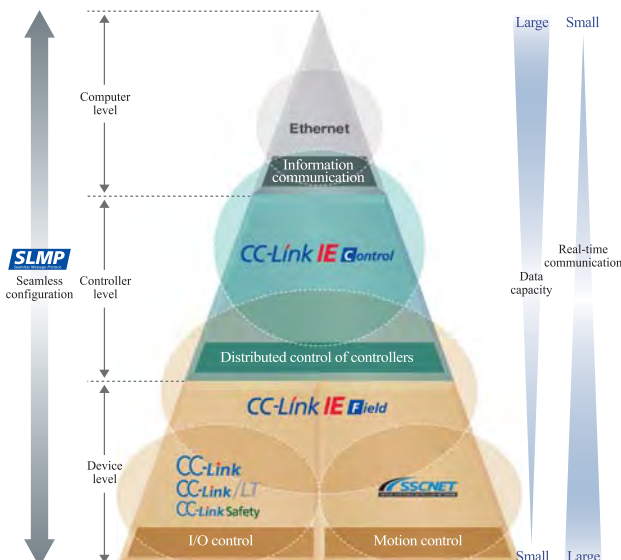

iQ Platform

A plant with increased "visualization" is also a plant with increased "energy saving".

Energy Save

In the plant where severe cost management is required, an even greater effort for energy reduction is essential.

Energy-saving solution of e-F@ctory offers an "aggressive energy conservation", which not only reduces the costs through energy saving but also assesses it totally to pump into new investment.

e&eco-F@ctory proposes precise management of every production equipment or production line and energy conservation plan based on the life cycle cost of production.



Comprehensively "visualize" energy is realized with e&eco-F@ctory.



Mitsubishi electric visualizes activities to improve productivity with standard data management, and strongly supports energy conservation activity.

"Measurement/diagnosis", "measures", and "management" are assessed as a total life cycle, while each abundant result and know-how are linked to achieve an effect.

Energy-saving solution of e-F@ctory will be used for future management strategy more effectively.

Generally, 10 to 30% of reduction effect is expectable by operation improvement with standard data management.

Effect of "visible management" introduction

- Compliance with Energy Conservation Law / execution of enhanced enforcement
- Optimization of energy usage by FEMS (Factory Energy Management System)
- "Visualization" of energy-saving effect
- Permeation of energy-saving activity to organization
- Promotion of operational restructuring / productivity improvement

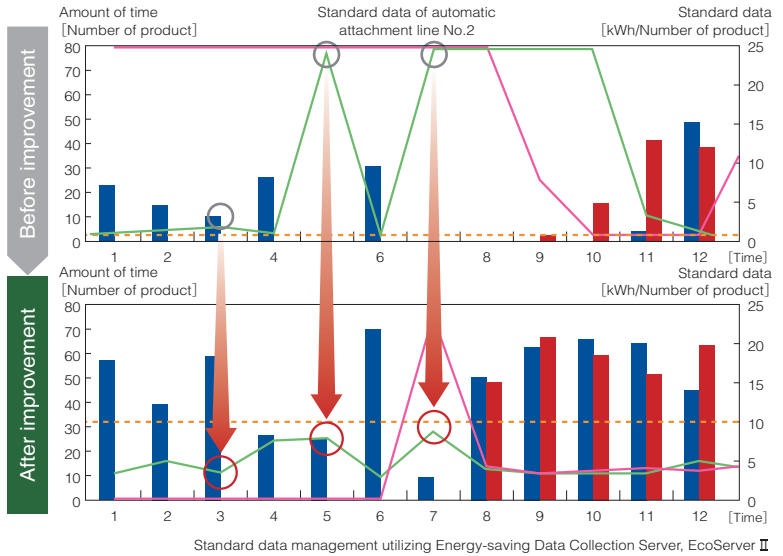

Comprehensive energy management with Energy-saving Database Server Software

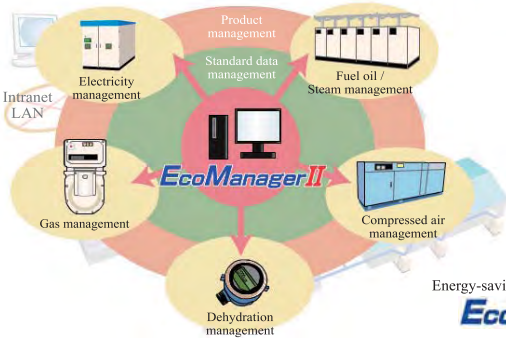

Energy-saving Database Server Software
EcoManager II

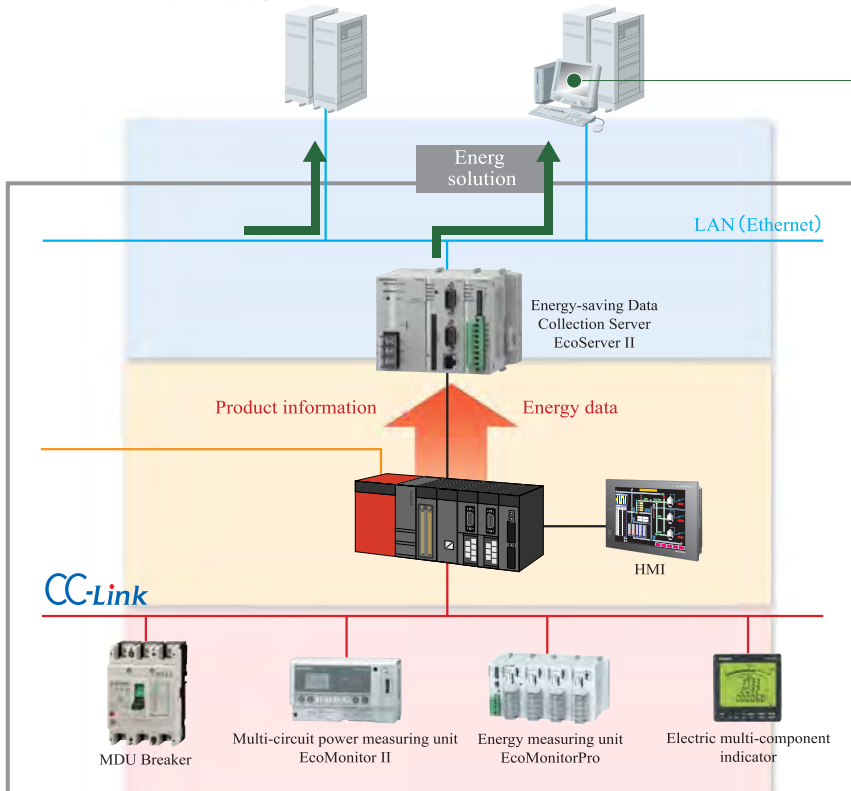

品番	名称	値
1	5線 電圧	6605 V
2	5線 200V 電流	25.7 A
3	5線 200V 電力量	104190 kWh
4	5線 100V 電流	0.25 A
5	5線 100V 電力量	79083 kWh
6	5線 5C 電流	26.2 A
7	5線 5C 電力量	20 kWh
8	5線 No.2MAG 電流	0.00 A
9	5線 No.2MAG 電力量	0 kWh
10	5線 T 573 # 200V 電流	0.0 A

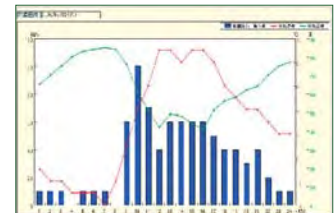
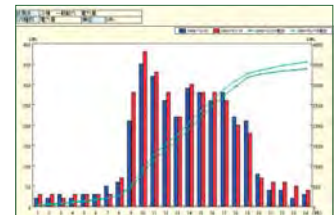

— LAN (Ethernet) — MELSECNET — CC-Link — CC-Link Safety

Energy Save

Fukuyama Works makes aggressive energy conservation efforts through "visible management."

Mitsubishi Electric's Fukuyama Works (Fukuyama City, Hiroshima Prefecture) adopted "visible management" in 1997, and now practices aggressive energy conservation efforts.

It has realized an economical and ecological eco-factory, and uses its eco expertise to engage in the energy conservation business.

Under its policy of "visible energy conservation,"

it visualizes all aspects of energy usage in the factory as it implements factory-wide energy conservation activities.

The knowledge it gains through these activities is incorporated in the development of energy-saving products.

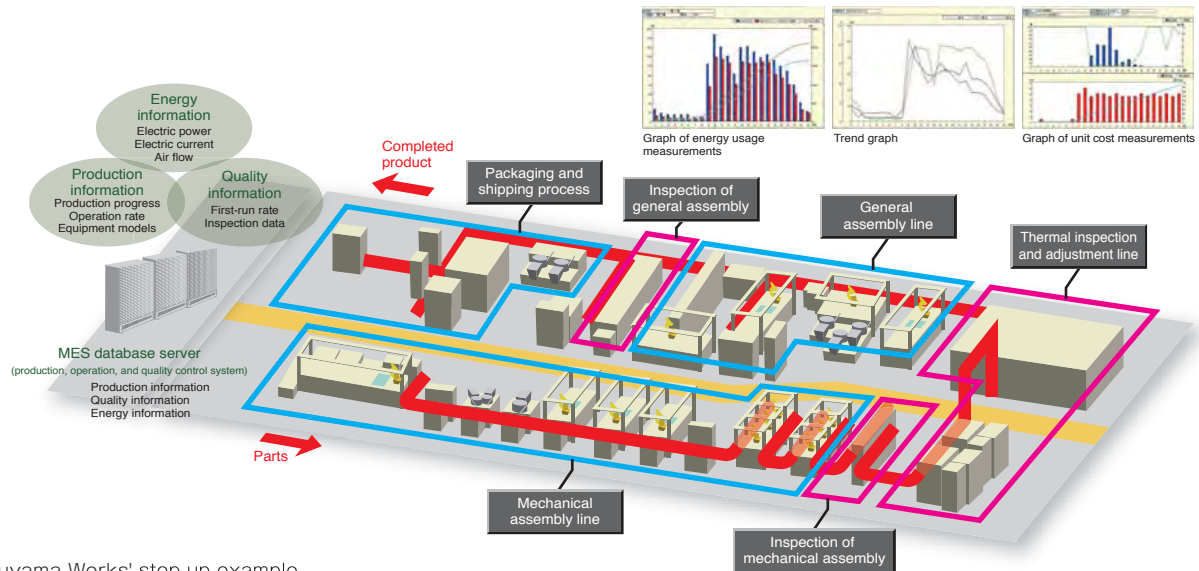

Fukuyama Works' step-up example

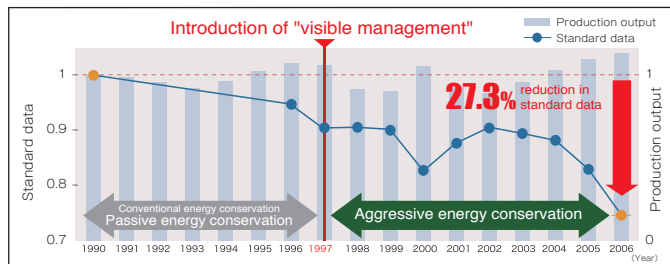

27.3% reduction in standard data
*2006 performance compared to 1990

Reduction of approx. **23 million yen** in basic power cost
*2006 performance compared to 1990

Reduction of approx. **100 million yen** in total power cost
*2006 performance compared to 1990

System for standard data management in each work process

System improvement

Support for reducing standard electric energy data

- System improvements are made by measuring the power usage and production output of each work process and managing standard data based on those measurements.
- "Visible management" is realized by using Intranet Web-based PCs.

Web-based energy conservation support system

Management and monitoring systems

Visible support of energy conservation activities

The Eco Server I Web-based data server makes accumulated data available on the Web via the Intranet in an easy understanding manner, to promote greater energy conservation efforts.

Visualization of energy usage

Data posted on an EMS Website accessible from a client PC

Web-based data server

Electric energy management system

Management and monitoring systems

Total support of energy and labor saving efforts in the factory

Electricity, gas, temperature, and other energy-related data in the factory is recorded and monitored in detail through a B/NET network of power distribution and control equipment.

LAN (Ethernet)

Slots directly into the PLC for simple measurement of diverse energy information!

■ PLC MELSEC-Q power measuring module

Meets Energy-Saving Measurement needs
I want to monitor the power used by each place of equipment, for detailed energy-saving monitoring.

Meets Short-Term Measurement needs
I want a fast measurement cycle to measure short-term loads.

Meets Quality Control needs
I want to detect power supply irregularities in manufacturing equipment to control product quality.

Meets Preventive Maintenance needs
I want to detect power and current used by manufacturing equipment and prevent sudden failures.

Meets Simple Installation needs
I want simple and smooth installation, with no program for power measurement.

MELSEC Q series

These are key e&eco-F@ctory products, achieving fusion between production and quality information, and energy information.

MELSEC-Q, a constant innovator in the production workplace, launches a new power measuring module. This unit makes it easy to measure current, voltage, power, power factor, effective power consumption and other information, integrating production and quality information with energy information, and leading to improved productivity, energy saving, and preventive maintenance. And, it slots directly into the PLC, saving space, wiring, and cost. It enables energy measurement for each piece of production equipment, preventive equipment maintenance based on realtime measurement, and the use of quality control indices linked to manufacturing information.

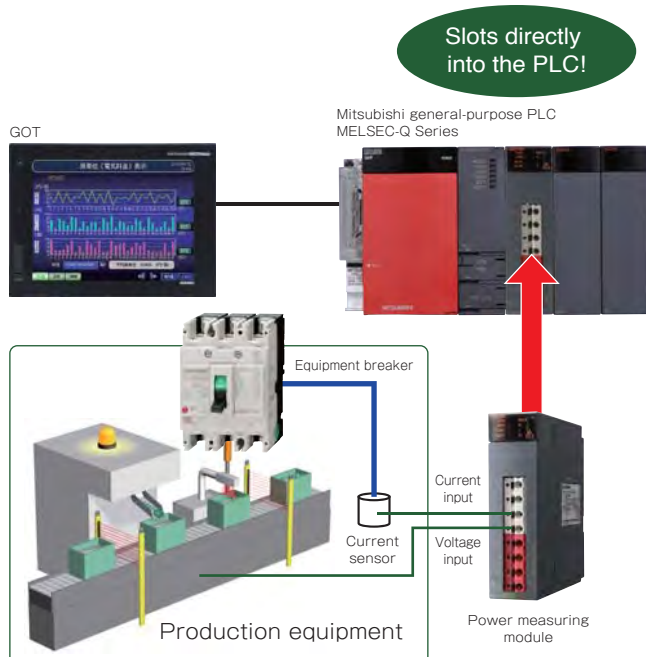

Slots directly into the PLC

The power measuring module is directly attached to the PLC, so there is no need to install any other instruments or connect wiring. There is no need for any major system construction either, so it also saves space.

Measure energy consumption simply

Read the signal from the current sensor on the device breaker, to measure energy consumed by the device. It's easy to grasp power consumption for each PLC unit and manage the standard data for each individual device.

Easy comparison of power consumption

Power can be measured only when a specific output signal is on. Power over a period can be measured at two points, to find the standby power consumed while idling or compare power consumed over a certain period.

Grasp the energy consumption status of a device

Record the maximum and minimum values of demand current, voltage, demand power and power factor for each device. Equalization of energy consumption is supported, to identify devices and times of high energy consumption.

Quickly catch abnormal device status

Set two measurement factors and monitor their upper and lower limit values. That makes it possible to quickly catch abnormal device status, and to find devices which are using large amounts of energy.

Energy Save

Mitsubishi Electric's model e-F@ctory plant has achieved a 190%*

Mitsubishi Electric operates a model e-F@ctory plant at Nagoya Works, to verify productivity and equipment operating rate through actual operations. Featuring a production system utilizing Mitsubishi's information-integrating FA products and solutions of partner manufacturers, the plant has made numerous outstanding achievements, such as 190% increase in equipment operating rate, 180% increase in productivity, and 65% reduction in system construction cost.*

Assembly line quality control example: Servo motor plant (began operations in May 2005)



Real-time quality control ensures quality improvement.

The figure shows the latest example of an e-F@ctory plant. It pursues efficient operation management, real-time QC, quality control, and energy management, under the themes of "meticulousness" and "real time." With MES Interface modules at its core, the system effectively links control systems and devices to an information system.

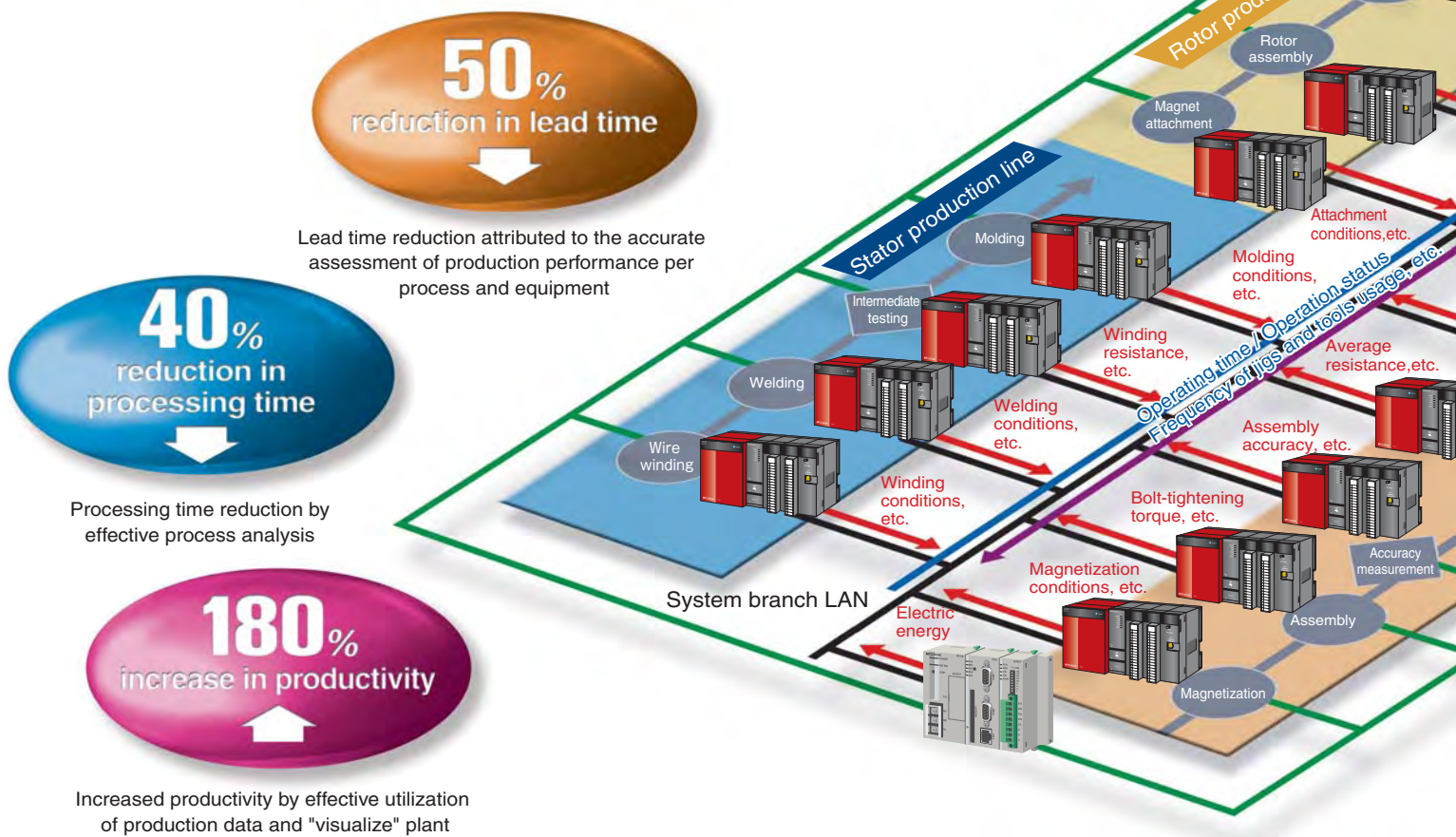

RFID application example in an assembly test cell:

Inverter/servo amplifier/power module plant (Began operations in March 2009)





The application of RFID to promote automation and management of individual equipment has led to significant quality improvement.

By using RFID tags to coordinate different work processes, it has become possible to keep a historical log of quality and other factors. Furthermore, a mechanism has been established to prevent defective items (human errors) from being carried over to the next work process.

*All figures are based on the performance of the e-F@ctory plant at Mitsubishi Electric's Nagoya Works, and on the results of eliminating PCs and programs.

increase in equipment operating rate.

- Quality information
- Operation information
- Instruction information
- Electric power information
-  PLC with MES Interface
-  EcoServer

190%
increase in
equipment operating rate

Increased equipment operating rate
by the optimum operation of shopfloor resources

65%
reduction in
system construction cost

System construction cost reduction
by the direct connections between the shopfloor
and information systems

10%
reduction in energy cost

Departmental management and detailed standard data
management with "visualize" energy

Electric power management, from the entire
shop floor to each production line, and from
each production line to each equipment.

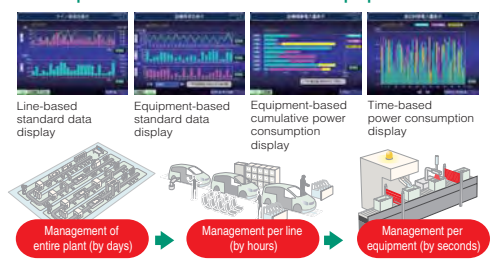

There are numerous advantages to managing power
consumption per equipment (by seconds).

[Power consumption per product can be assessed]
The amount of power used by each product category can be assessed
as an accurate manufacturing cost. The amount of power that is
wasted by the occurrence of rejects can be assessed.

[Power consumption per state of each equipment can be assessed]
The amount of power that is wasted during standby mode
and malfunctions can be assessed.

60%
decrease in
manufacturing schedules

Shortened manufacturing schedules
by detailed planning
based on production plans
and real-time
shopfloor information

50%
reduction in quality loss

"Zero defect" achievement
by preventing the defect incorporation
and process skipping

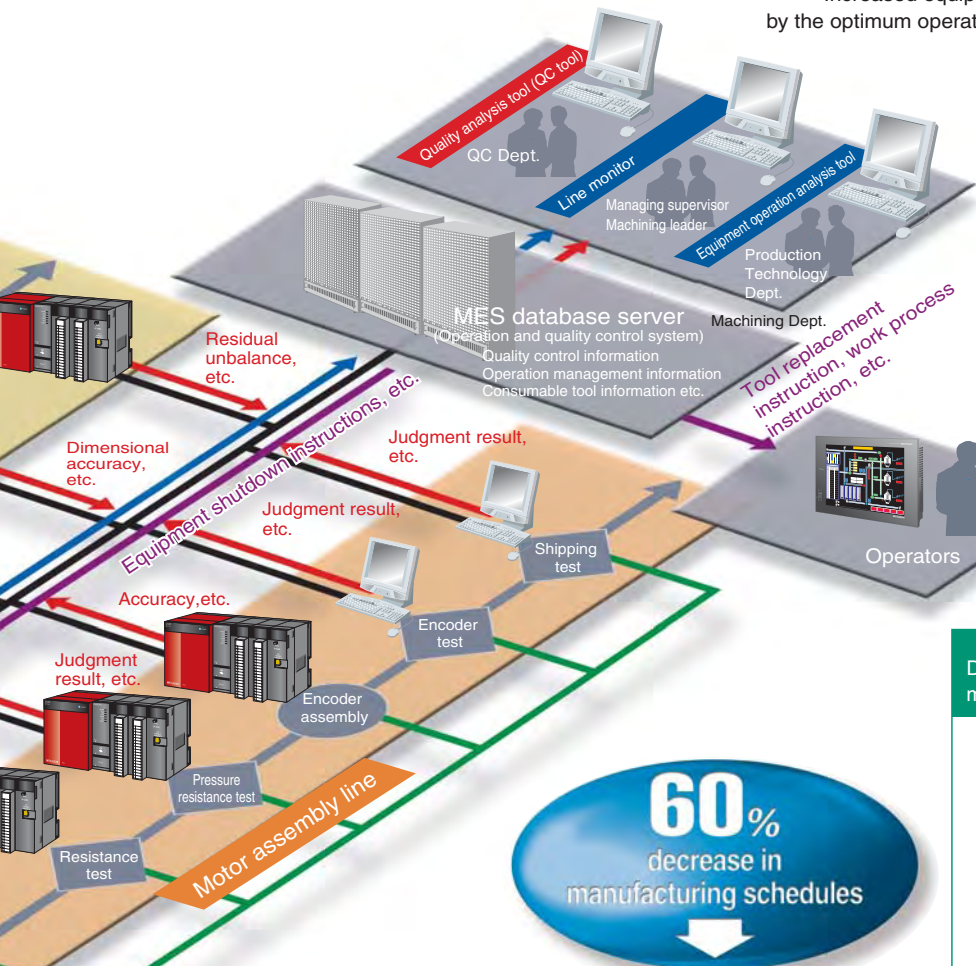

Machine processing line process control example:
Electrical discharge machine machining plant (began operations in September 2003)



High production efficiency has been achieved through detailed process control.

The e-F@ctory platform was applied to an electrical discharge machine plant in which production plans were formulated manually and no network system had yet been introduced. Shopfloor issues were made directly "visible," by focusing on production scheduling and tool information management, and a "visible" shopfloor has led to the efficient operation of devices and equipments and the optimization of the entire production system.

e-F@ctory Concept

Mitsubishi FA Integrated Solution e-F@ctory

Country/Region Sales office

USA	Mitsubishi Electric Automation Inc. 500 Corporate Woods Parkway, Vernon Hills, IL 60061, USA	Tel : +1-847-478-2100 Fax : +1-847-478-0327
Brazil	MELCO-TEC Rep. Com.e Assessoria Tecnica Ltda. Rua Correia Dias, 184, Edificio Paraiso Trade Center-8 andar Paraiso, Sao Paulo, SP Brasil	Tel : +55-11-5908-8331 Fax : +55-11-5574-5296
Germany	Mitsubishi Electric Europe B.V. German Branch Gothaer Strasse 8, D-40880 Ratingen, Germany	Tel : +49-2102-486-0 Fax : +49-2102-486-1120
UK	Mitsubishi Electric Europe B.V. UK Branch Travellers Lane, Hatfield, Hertfordshire, AL10 8XB, UK	Tel : +44-1707-276100 Fax : +44-1707-278992
Italy	Mitsubishi Electric Europe B.V. Italian Branch Viale Colleoni 7-20041 Agrate Brianza(Milano),Italy	Tel : +39-39-60531 Fax : +39-39-6053312
Spain	Mitsubishi Electric Europe B.V. Spanish Branch Carretera de Rubi 76-80 E-08190 Sant Cugat del Valles(Barcelona), Spain	Tel : +34-93-565-3131 Fax : +34-93-589-1579
France	Mitsubishi Electric Europe B.V. French Branch 25,Boulevard des Bouvets, F-92741 Nanterre Cedex, France	Tel : +33-1-5568-5568 Fax : +33-1-5568-5757
South Africa	Circuit Breaker Industries Ltd. Private Bag 2016, ZA-1600 Isando, South Africa	Tel : +27-11-928-2000 Fax : +27-11-392-2354
Hong Kong	Mitsubishi Electric Automation(Hong Kong) Ltd. 10F, Manulife Tower, 169 Electric Road, North Point, HongKong	Tel : +852-2887-8870 Fax : +852-2887-7984
China	Mitsubishi Electric Automaiton(Shanghai) Ltd. 4F Zhi Fu Plazz, No.80 Xin Chang Road Shanghai 200003, China	Tel : +86-21-6120-0808 Fax : +86-21-6121-2424
Taiwan	Setsuyo Enterprise Co., Ltd. 6F, No.105 Wu-Kung 3rd Rd, Wu-Ku Hsiang, Taipei Hsine, Taiwan	Tel : +886-2-2299-2499 Fax : +886-2-2299-2509
Korea	Mitsubishi Electric Automation Korea Co., Ltd. 3F, 1480-6, Gayang-dong, Gangseo-gu, Seoul 157-200, Korea	Tel : +82-2-3660-9552 Fax : +82-2-3664-8372
Singapore	Mitsubishi Electric Asia Pte, Ltd. 307 Alexandra Road #05-01/02, Mitsubishi Electric Bulding Singapore 159943	Tel : +65-6470-2460 Fax : +65-6476-7439
Thailand	Mitsubishi Electric Automation (Thailand) Co.,Ltd. Bang-Chan Industrial Estate No.111, Soi Serithai 54, T. Kannayao, 10230 Thailand	Tel : +66-2-517-2316 Fax : +66-2-906-3239
Indonesia	P.T. Autoteknindo Sumber Makmur Muara Karang Selatan Block A/Utara No.1 Kav. No.11 Kawasan Industri/Pergudangan, Jakarta-Utara P.O Box5045 Jakarta 11050, Indonesia	Tel : +62-21-663-0833 Fax : +62-21-663-0832
India	Messung Systems Pvt.,Ltd. Electronic Sadan NO: III Unit No15, M.I.D.C Bhosari, Pune-411026, India	Tel : +91-20-2712-3130 Fax : +91-20-2712-8108
Australia	Mitsubishi Electric Australia Pty.Ltd. 348 Victoria Road, Rydalmere, NSW 2116, Australia	Tel : +61-2-9684-7777 Fax : +61-2-9684-7245

"e-F@ctory" is a registered trademark of Mitsubishi Electric Corporation.
All other company names and production names in this document are
the trademarks or registered trademarks of their respective owners.



Safety Precaution

To ensure proper use of the products presented in this catalog,
be sure to read the "Operating Instruction" prior to use.

Nagoya works have acquired the certification for Environmental management
system ISO 14001 and Quality assurance management system ISO 9001



Revised publication, effective May 2012.
Superseding publication of L(NA)16012E-B Mar. 2010.
Specifications are subject to change without notice.